

	Mon	Tue	Wed	Thu	Fri
1					
2	X			X	
3			X		
4					
5	X				

# Pricelist 2011



**Prices** All prices in GBP exclusive of VAT. Valid from 01.01.2011. Quotations are valid for 30 days unless otherwise agreed.

**Conditions of payment** 30 days net. Interest charged for non-payment according to current terms. All goods remain the property of RH Chairs until payment is made in full.

**Conditions of delivery** Ex. works, including packaging.

**Delivery times** Non stock chairs are dispatched from the factory during the stated week of delivery. Alterations to an order must be received at least two weeks before delivery date.

**Damage in transit** Should it be apparent that goods have been damaged in transit, the recipient/customer must inform the supplier within 48 hours of receipt.

**Warranty** All Products carry a 10 year warranty from date of delivery with the following exceptions:  
RH Logic 3, RH Logic 4, RH Support, RH Session, RH Visit, RH Lounge and relax armrests: These have 5 Years.

For usage over 8 hours a day (24 hour use) 5 years applies, valid for RH Logic 4, RH Logic 300 or RH Logic 400. Please note we only offer a 5 year warranty on leather and 24/7 fabric when chairs are used in 24 hour environments. Standard fabrics in a 24 hour environment carry a 2 year warranty.

ESD, ESD Cleanroom and Cleanroom performance is guaranteed for 5 years providing that castors/glides are properly cleaned and cared for. The warranty covers all parts and our standard upholstery options, provided that the chairs are used with due care under normal conditions (8 hours a day). Any service or freight charges are not covered under our standard warranty.

C.O.M fabrics can be used providing they have been accepted by RH Chairs.

Accepted C.O.M fabrics are not covered under the normal warranty, unless the fabric is covered by the fabric manufacturer.

Valid for chairs delivered after 01.01.2011.

**Quality** RH Chairs is ISO 9001 accredited. Most chair models are tested and approved in accordance with the most stringent British and European regulations including: BS 5459 part 2, BS/EN 1335-1 (measurement requirements), BS/EN 1335-2 (safety requirements), BS/EN 1335-3 (testing methods). BS/EN 1335-1 also includes three classifications, classes A, B and C. All measurements given in the pricelist are based on BS/EN1335-1. The seat height will vary in accordance with the weight of the user. Please contact us for further information or test reports. Many of our products has also been awarded with the FIRA Ergonomics Excellence award.

**Environmental responsibility** Environmental considerations are at the heart of our business. All RH chairs are made from materials that can be recycled. A complete list of recyclable materials used for each chair model and our environmental brochure are available on request. We are certified in accordance with ISO 14001.

RH Activ, RH Ambio, RH Logic 400 and RH Extend are certified according to the EPD (Environmental Product Declaration) ISO14025. Since 2010 is also RH Activ, RH Ambio, RH Extend, RH Logic 300 / 400 and RH Support certified by the Greenguard Environmental Institute's certification program.

**Fire classification** Foams and standard fabrics are tested to BS/EN 1021-1&2 and BS 5852 part 1 and part 2 (cigarettes, open flame and crib test, source 5). Ambio pads with standard fabrics are tested to BS/EN 1021-1&2.

**Upholstery** We offer a variety of upholstery options. Read more on page 44-45 of these collections.

All our collections are selected with at least a 5-year warranty for normal office use excluding normal wear and tear.

Please contact us for further information. For product news, please visit [www.rhchairs.co.uk](http://www.rhchairs.co.uk)

RH Ambio	4
RH Session	8
RH Visit	10
RH Lounge	13
RH Extend	14
RH Logic 300	16
RH Logic 400	18
RH Logic 3-4	20
RH Activ	24
RH Support	28
RH ESD	32
RH Activ ESD Cleanroom	38
RH Activ Cleanroom	40
Flexible arm supports	43
Replacement pads	43
Fabric requirements	inside cover
Upholstery	inside cover

## RH Ambio 200

Art. no 5112

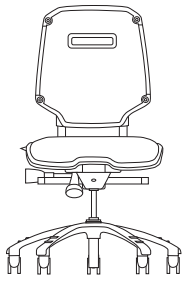
**RH Ambio 200**

**Backrest medium:** width 440 mm, height 480 mm  
**Seat medium:** width 465 mm, depth 430 mm  
**Seat height:** 435-555 mm (4P)  
**Base in lacquered aluminium with castors**  
 Dimension spec. as per EN 1335 (see page 2 under Test)

**5112-1**

Standard spec as per above

**5112-2**

As above plus silver lacquered frame

**5112-3**

**The Elegance pack**, as standard plus silver lacquered frame and upholstered back shell

**5112-4**

**The Elegance Leather pack**, as 5112-3 but in leather

Art. no	Upholstery	Price
5112-1	Fabric Move	£ 605
5112-2	Fabric Move	£ 634
5112-3	Fabric Move	£ 692
5112-4	Leather	£ 968

## RH Ambio 220

Art. no 5212

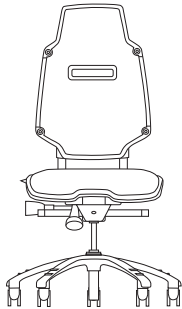
**RH Ambio 220**

**Backrest large:** width 440 mm, height 600 mm  
**Seat medium:** width 465 mm, depth 430 mm  
**Seat height:** 435-555 mm (4P)  
**Base in lacquered aluminium with castors**  
 Dimension spec. as per EN 1335 (see page 2 under Test)

**5212-1**

Standard spec as per above

**5212-2**

As above plus silver lacquered frame

**5212-3**

**The Elegance pack**, as standard plus silver lacquered frame and upholstered back shell

**5212-4**

**The Elegance Leather pack**, as 5212-3 but in leather

Art. no	Upholstery	Price
5212-1	Fabric Move	£ 644
5212-2	Fabric Move	£ 673
5212-3	Fabric Move	£ 744
5212-4	Leather	£ 1020

## RH Ambio 202

Art. no 5122

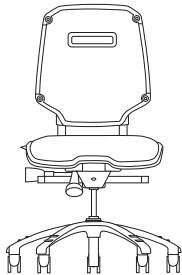
**RH Ambio 202 (Large seat)**

**Backrest medium:** width 440 mm, height 480 mm  
**Seat large:** width 465 mm, depth 485 mm  
**Seat height:** 435-555 mm (4P)  
**Base in lacquered aluminium with castors**  
 Dimension spec. as per EN 1335 (see page 2 under Test)

**5122-1**

Standard spec as per above

**5122-2**

As above plus silver lacquered frame

**5122-3**

**The Elegance pack**, as standard plus silver lacquered frame and upholstered back shell

**5122-4**

**The Elegance Leather pack**, as 5122-3 but in leather

Art. no	Upholstery	Price
5122-1	Fabric Move	£ 649
5122-2	Fabric Move	£ 678
5122-3	Fabric Move	£ 736
5122-4	Leather	£ 1012

## RH Ambio 222

Art. no 5222

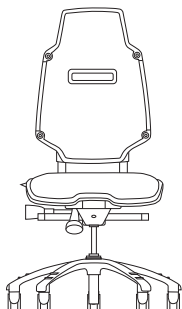
**RH Ambio 222 (Large seat)**

**Backrest large:** width 440 mm, height 600 mm  
**Seat large:** width 465 mm, depth 485 mm  
**Seat height:** 435-555 mm (4P)  
**Base in lacquered aluminium with castors**  
 Dimension spec. as per EN 1335 (see page 2 under Test)

**5222-1**

Standard spec as per above

**5222-2**

As above plus silver lacquered frame

**5222-3**

**The Elegance pack**, as standard plus silver lacquered frame and upholstered back shell

**5222-4**

**The Elegance Leather pack**, as 5222-3 but in leather

Art. no	Upholstery	Price
5222-1	Fabric Move	£ 688
5222-2	Fabric Move	£ 717
5222-3	Fabric Move	£ 788
5222-4	Leather	£ 1064

## Accessories/Options RH Ambio

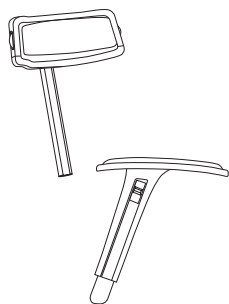

<b>Neckrest</b> (Only for Large backrest) Fabric Move Adjustable in height and depth	<b>Art. no</b>		<b>Price</b>
	105010	Standard	£ 83
	105020	The Elegance pack*	£ 88
<b>Neckrest</b> (Only for Large backrest) Leather Adjustable in height and depth2	<b>Art. no</b>		<b>Price</b>
	105011	Standard	£ 108
	105021	The Elegance pack*	£ 113
<b>Armrest</b> 8P Adjustable in height and width, rotating Armrest height above seat 195–280 mm	<b>Art. no</b>		<b>Price/pair</b>
	805000	Standard	£ 82
	805001	The Elegance pack*	£ 88
<b>Upholstered armrest</b> 8P Leather Adjustable in height and width, rotating Armrest height above seat 195–280 mm	<b>Art. no</b>		<b>Price/pair</b>
	805002	Standard	£ 118
	805003	The Elegance pack*	£ 124
	805003	The Elegance pack leather*	£ 124

\* incl silver frame



<b>Upholstered backshell</b> Fabric Move	<b>Art. no</b>		<b>Price</b>
	160009	Backrest medium	£ 58
	160008	Backrest large	£ 71
<b>Gas stem</b> 4Q For seat height 395–515 mm	<b>Art. no</b>		<b>Price</b>
	520001	Class A	£ 0
B For seat height 480–610 mm	520020-01	High	£ 0

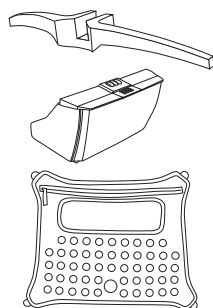

<b>Accessories</b> (Only for backrest large) Incl. coat hanger, lockable storage box and detachable soft case	<b>Art. no</b>		<b>Price</b>
	905000		£ 89
<b>Coat hanger</b> (Only for backrest large)	<b>Art. no</b>		<b>Price</b>
	930004-01		£ 30
<b>Lockable storage box</b>	<b>Art. no</b>		<b>Price</b>
	900001		£ 42
<b>Detachable soft case</b>	<b>Art. no</b>		<b>Price</b>
	905001		£ 30

## RH Ambio 200 Black Edition

Art. no 5112

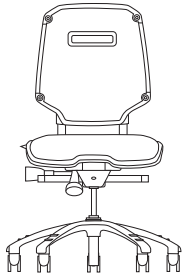
**RH Ambio 200 Black Edition**

**Backrest medium:** width 440 mm,  
height 480 mm  
**Seat medium:** width 465 mm, depth 430 mm  
**Seat height:** 435-555 mm (4P Black)  
**Base in black lacquered aluminium with castors**

Dimension spec. as per EN 1335 (see page 2 under Test)

**5112-30**

**Black Edition**, as standard with upholstered back shell

**5112-40**

**Black Edition Leather**, as 5112-30 but in leather

Art. no	Upholstery	Price
5112-30	Fabric Move 9105	£ 674
5112-40	Leather black	£ 950

## RH Ambio 220 Black Edition

Art. no 5212

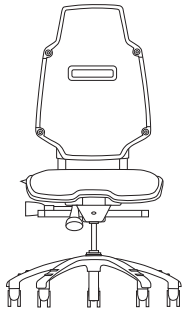
**RH Ambio 220 Black Edition**

**Backrest large:** width 440 mm,  
height 600 mm  
**Seat medium:** width 465 mm, depth 430 mm  
**Seat height:** 435-555 mm (4P Black)  
**Base in black lacquered aluminium with castors**

Dimension spec. as per EN 1335 (see page 2 under Test)

**5212-30**

**Black Edition**, as standard with upholstered back shell

**5212-40**

**Black Edition Leather**, as 5212-30 but in leather

Art. no	Upholstery	Price
5212-30	Fabric Move 9105	£ 726
5212-40	Leather black	£ 1002

## RH Ambio 202 Black Edition

Art. no 5122

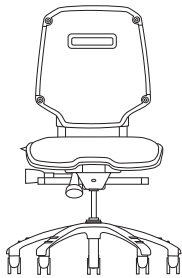
**RH Ambio 202 Black Edition (Large seat)**

**Backrest medium:** width 440 mm,  
height 480 mm  
**Seat large:** width 465 mm, depth 485 mm  
**Seat height:** 435-555 mm (4P Black)  
**Base in black lacquered aluminium with castors**

Dimension spec. as per EN 1335 (see page 2 under Test)

**5122-30**

**Black Edition**, as standard with upholstered back shell

**5122-40**

**Black Edition Leather**, as 5122-30 but in leather

Art. no	Upholstery	Price
5122-30	Fabric Move 9105	£ 718
5122-40	Leather black	£ 994

## RH Ambio 222 Black Edition

Art. no 5222

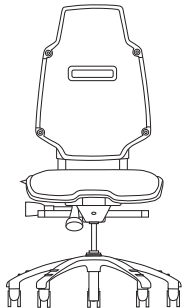
**RH Ambio 222 Black Edition (Large seat)**

**Backrest large:** width 440 mm,  
height 600 mm  
**Seat large:** width 465 mm, depth 485 mm  
**Seat height:** 435-555 mm (4P Black)  
**Base in black lacquered aluminium with castors**

Dimension spec. as per EN 1335 (see page 2 under Test)

**5222-30**

**Black Edition**, as standard with upholstered back shell

**5222-40**

**Black Edition Leather**, as 5222-30 but in leather

Art. no	Upholstery	Price
5222-30	Fabric Move 9105	£ 770
5222-40	Leather black	£ 1046

## Accessories/Options RH Ambio Black Edition

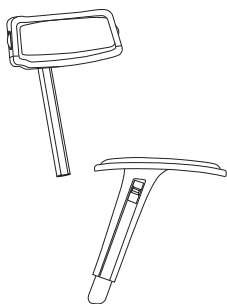

**Neckrest**  
(Only for backrest large)  
Fabric Move 9105  
Adjustable in height and depth

**Neckrest**  
(Only for backrest large)  
Leather black  
Adjustable in height and depth

**Upholstered armrest**  
8P  
Leather black  
Adjustable in height and width, rotating  
Armrest height above seat 195–280 mm

<b>Art. no</b>		<b>Price</b>
105030-13	Black Edition	£ 88
<b>Art. no</b>		<b>Price</b>
105031-02	Black Edition	£ 113
<b>Art. no</b>		<b>Price/pair</b>
805004-21	Black Edition	£ 124

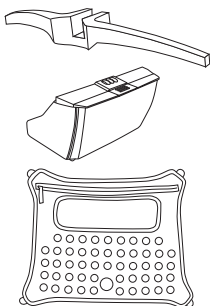

**Accessories Black Edition**  
(Only for backrest large)  
Incl. coat hanger, lockable storage box and detachable soft case

**Coat hanger**  
(Only for backrest large)  
Black

**Lockable storage box**  
Black

**Detachable soft case**

<b>Art. no</b>		<b>Price</b>
905000-05		£ 89
<b>Art. no</b>		<b>Price</b>
930004-05		£ 30
<b>Art. no</b>		<b>Price</b>
900001-05		£ 42
<b>Art. no</b>		<b>Price</b>
905001		£ 30



**Gas stem**  
4Q  
for seat height 395–515 mm

B Black  
for seat height 480–610 mm

<b>Art. no</b>		<b>Price</b>
520001-05		£ 0
520020-02		£ 0

RH Session

Art. no 5430

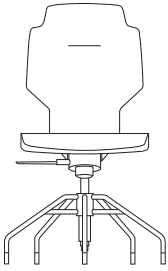

**RH Session**  
 Seat width: 465 mm  
 Total depth: 570 mm  
 Total height: 910-1020 mm  
 Seat height: 400-510 mm  
 Base Ø 560 mm in steel with glides

Upholstery price group	Price
Customer fabric	£ 390
1	£ 378
2	£ 383
3	£ 390
4	£ 412
5	£ 440
6	£ 525

RH Session

Art. no 5431

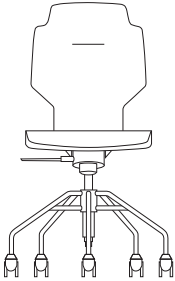

**RH Session**  
 Seat width: 465 mm  
 Total depth: 570 mm  
 Total height: 940-1050 mm  
 Seat height: 430-540 mm  
 Base Ø 560 mm in steel with castors

Upholstery price group	Price
Customer fabric	£ 415
1	£ 403
2	£ 408
3	£ 415
4	£ 437
5	£ 465
6	£ 550

## RH Session

Art. no 5435

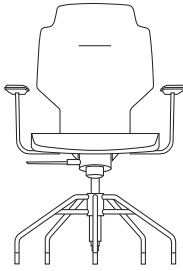
**RH Session with armrest**

Total width: 640 mm

Total depth: 570 mm

Total height: 910-1020 mm

Seat height: 400-510 mm

Base Ø 560 mm in steel with glides Arm rests in anthracite grey lacquered wood with leather upholstered arm tops

**Upholstery price group**

Customer fabric

1

2

3

4

5

6

**Price**

£ 420

£ 408

£ 413

£ 420

£ 442

£ 470

£ 555

## RH Session

Art. no 5436

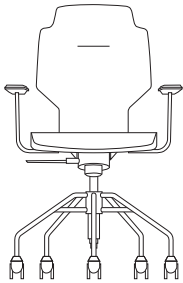
**RH Session with armrest**

Total width: 640 mm

Total depth: 570 mm

Total height: 940-1050 mm

Seat height: 430-540 mm

Base Ø 560 mm in steel with castors Arm rests in anthracite grey lacquered wood with leather upholstered arm tops

**Upholstery price group**

Customer fabric

1

2

3

4

5

6

**Price**

£ 445

£ 433

£ 438

£ 445

£ 467

£ 495

£ 580

## RH Visit

Art. no 5410

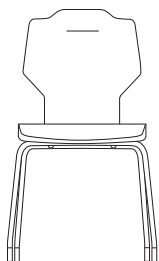
**RH Visit**

Seat width: 445 mm  
 Total depth: 540 mm  
 Total height: 914 mm  
 Seat height: 450 mm  
 Frame in steel with glides

Stackable

Long term stacking may result in marks on the seat cushion and can damage some types of upholstery

**Upholstery price group**

Customer fabric

**Price**

£ 238  
 1 £ 226  
 2 £ 231  
 3 £ 238  
 4 £ 260  
 5 £ 288  
 6 £ 349

## RH Visit

Art. no 5411

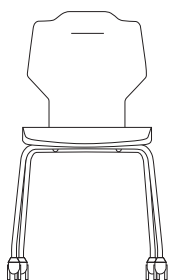
**RH Visit**

Seat width: 445 mm  
 Total depth: 540 mm  
 Total height: 914 mm  
 Seat height: 450 mm  
 Frame in steel with castors

Stackable

Long term stacking may result in marks on the seat cushion and can damage some types of upholstery.

**Upholstery price group**

Customer fabric

**Price**

£ 258  
 1 £ 246  
 2 £ 251  
 3 £ 258  
 4 £ 280  
 5 £ 308  
 6 £ 369

## Accessories/Options

**Connectors**

Enabling multiple chairs to be anchored side-by-side

**Art. no**

930009

**Price**

£ 1

RH Visit

Art. no 5415

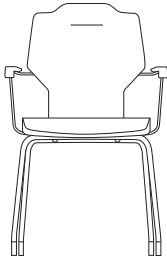

**RH Visit with armrest**

Seat width: 445 mm

Total depth: 540 mm

Total height: 914 mm

Seat height: 450 mm

Frame in steel with glides

Armrests with anthracite grey lacquered wood

Stackable

Long term stacking may result in marks on the seat cushion and can damage some types of upholstery

**Upholstery price group**

Customer fabric

1

2

3

4

5

6

**Price**

£ 268

£ 256

£ 261

£ 268

£ 290

£ 318

£ 379

RH Visit

Art. no 5416

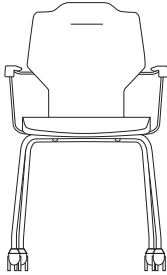

**RH Visit with armrest**

Seat width: 445 mm

Total depth: 540 mm

Total height: 914 mm

Seat height: 450 mm

Frame in steel with castors

Armrests with anthracite grey lacquered wood

Stackable

Long term stacking may result in marks on the seat cushion and can damage some types of upholstery

**Upholstery price group**

Customer fabric

1

2

3

4

5

6

**Price**

£ 288

£ 276

£ 281

£ 288

£ 310

£ 338

£ 399

Accessories/Options

**Connectors**

Enabling multiple chairs to be anchored side-by-side

**Art. no**

930009

**Price**

£ 1

RH Visit Cantilever

Art. no 5420

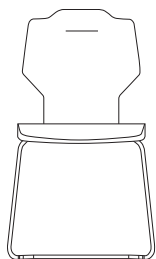

**RH Visit Cantilever**  
 Seat width: 445 mm  
 Total depth: 540 mm  
 Total height: 914 mm  
 Seat height: 450 mm  
 Frame in steel with glides

Upholstery price group	Price
Customer fabric	£ 238
1	£ 226
2	£ 231
3	£ 238
4	£ 260
5	£ 288
6	£ 349

RH Visit Cantilever

Art. no 5425

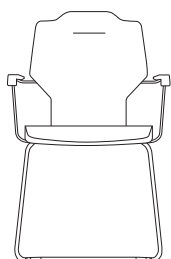

**RH Visit Cantilever with armrest**  
 Seat width: 445 mm  
 Total depth: 540 mm  
 Total height: 914 mm  
 Seat height: 450 mm  
 Frame in steel with glides  
 Armrests with anthracite grey lacquered wood

Upholstery price group	Price
Customer fabric	£ 268
1	£ 256
2	£ 261
3	£ 268
4	£ 290
5	£ 318
6	£ 379

Accessories/Options

Connectors	Art. no	Price
Enabling multiple chairs to be anchored side-by-side	930009	£ 1

## RH Lounge

Art. no 5440

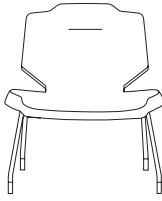

**RH Lounge**  
 Seat width: 640 mm  
 Total depth: 710 mm  
 Total height: 790 mm  
 Seat height: 365 mm  
 Frame in steel with glides

Upholstery price group	Price
Customer fabric	£ 471
1	£ 453
2	£ 462
3	£ 471
4	£ 500
5	£ 541
6	£ 633

## RH Lounge

Art. no 5445

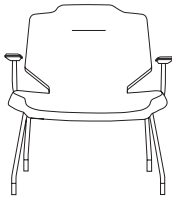

**RH Lounge**  
 Total width: 785 mm  
 Seat width: 640 mm  
 Total depth: 710 mm  
 Total height: 790 mm  
 Seat height: 365 mm  
 Frame in steel with glides  
 Arm rests in anthracite grey lacquered  
 wood with leather upholstered  
 arm tops

Upholstery price group	Price
Customer fabric	£ 501
1	£ 483
2	£ 492
3	£ 501
4	£ 530
5	£ 571
6	£ 663

## RH Extend 100

Art. no 6111

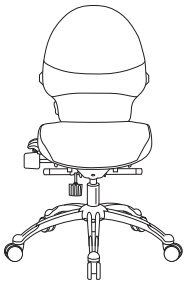
**RH Extend 100**

**Backrest medium:** width 440 mm, height 510 mm  
**Seat:** width 460 mm, depth 470 mm (seatslide 60 mm)  
**Seat height:** 400–510 mm (4Q)  
**Base in grey lacquered aluminium (5M) and castors for carpeted floors (Ø 65mm)**

Dimension spec. as per EN 1335-1 Class B (see page 2 under Quality)

**Neckrest Cassette**

If ordering a RH Extend 100 without neckrest you must add a neckrest cassette in order to equip the chair with a neckrest at a later stage

**Upholstery price group**

Customer fabric

**Price**

£ 459  
 1 £ 453  
 2 £ 457  
 3 £ 459  
 4 £ 475  
 5 £ 507  
 6 £ 548

## RH Extend 120

Art. no 6211

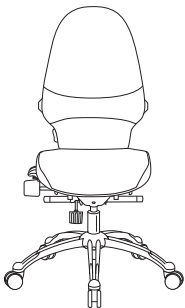
**RH Extend 120**

**Backrest large:** width 440 mm, height 620 mm  
**Seat:** width 460 mm, depth 470 mm (seatslide 60 mm)  
**Seat height:** 400–510 mm (4Q)  
**Base in grey lacquered aluminium (5M) and castors for carpeted floors (Ø 65mm)**

Dimension spec. as per EN 1335-1 Class B (see page 2 under Quality)

**Upholstery price group**

Customer fabric

**Price**

£ 508  
 1 £ 502  
 2 £ 506  
 3 £ 508  
 4 £ 524  
 5 £ 556  
 6 £ 620

## RH Extend 200

Art. no 6112

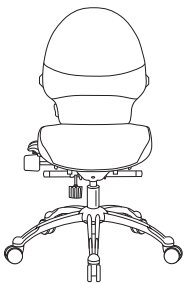
**RH Extend 200**

**Backrest medium:** width 440 mm, height 510 mm  
**Seat:** width 460 mm, depth 470 mm (seatslide 60 mm)  
**Seat height:** 400–510 mm (4Q)  
**Base in grey lacquered aluminium (5M) and castors for carpeted floors (Ø 65mm)**

Dimension spec. as per EN 1335-1 Class B (see page 2 under Quality)

**Neckrest Cassette**

If ordering a RH Extend 100 without neckrest you must add a neckrest cassette in order to equip the chair with a neckrest at a later stage

**Upholstery price group**

Customer fabric

**Price**

£ 551  
 1 £ 545  
 2 £ 549  
 3 £ 551  
 4 £ 567  
 5 £ 599  
 6 £ 640

## RH Extend 220

Art. no 6212

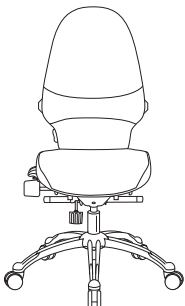
**RH Extend 220**

**Backrest large:** width 440 mm, height 620 mm  
**Seat:** width 460 mm, depth 470 mm (seatslide 60 mm)  
**Seat height:** 400–510 mm (4Q)  
**Base in grey lacquered aluminium (5M) and castors for carpeted floors (Ø 65mm)**

Dimension spec. as per EN 1335-1 Class B (see page 2 under Quality)

**Upholstery price group**

Customer fabric

**Price**

£ 601  
 1 £ 595  
 2 £ 599  
 3 £ 601  
 4 £ 617  
 5 £ 649  
 6 £ 713

## Accessories/Options RH Extend

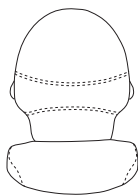

<b>Neckrest Extend</b> Height and depth adjustable	<b>Art. no</b> 100023	<b>Price</b> £ 80
<b>Neckrest pad</b> Replacement pad for neckrest	<b>Art. no</b> 100026	<b>Price</b> £ 34
<b>Neckrest Cassette</b> To enable a neck rest to be fitted at a later stage for medium back.	<b>Art. no</b> 15041	<b>Price</b> £ 4
<b>Decorative stitching</b>	<b>Art. no</b> 905005	<b>Price</b> £ 47

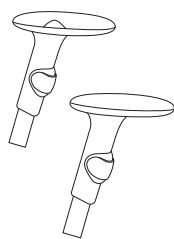

	<b>Art. no</b>		<b>Price/pair</b>
<b>Armrest</b> 8S Adjustable in height and width. Rotating. Armrest height above seat 215–295 mm	8300150	Grey	£ 80
	8300150-02	Black	£ 80
8S Class A Adjustable in height and width. Rotating. Armrest height above seat 200–280 mm	8300100	Grey	£ 80
	8300100-02	Black	£ 80
8E Adjustable in height, depth and width. Armrest height above seat 215–295 mm	8700300	Grey	£ 84
	8700300-02	Black	£ 84
	8700200	Upholstery leather	£ 122
	8700200-02	Black/Upholstery leather	£ 122
8E Class A Adjustable in height, depth and width. Armrest height above seat 200–280 mm	87000	Grey	£ 84
	87000-02	Black	£ 84
	8700250	Upholstery leather	£ 122
	8700250-02	Black/Upholstery leather	£ 122

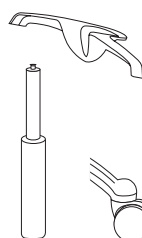

<b>Coat hanger</b>	<b>Art. no</b> 111050	<b>Price</b> £ 28
<b>Gas stem</b> 4P For seat height 440-550 mm	<b>Art. no</b> 520011	<b>Price</b> £ 0
	520011-05	£ 0
	520011-05	£ 0
4P Black For seat height 440-550 mm		
4Q Black For seat height 400-510 mm	520001-05	£ 0
<b>Castor</b> For hard floors Ø 65 mm	<b>Art. no</b> 125177	<b>Price</b> Set of 5 £ 0

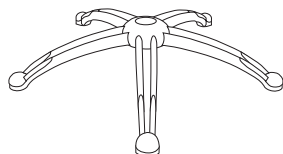

<b>Base</b> 5MP Ø 660 mm, polished aluminium	<b>Art. no</b> 5203000-01	<b>Price</b> £ 37
	5203000-05	£ 0
5M Black Ø 660 mm, black lacquered aluminium		

RH Logic 300

Art. no 3340

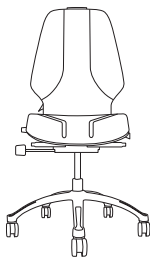

**RH Logic 300**

Backrest RH300: width 440 mm, height 510 mm

Seat RH400: width 465 mm, depth 475 mm  
(seatslide 60 mm)

Seat height: 410-530 mm (4Q)

Base in graphite aluminium (5X) and castors for  
carpeted floors (Ø 65mm)

Dimension spec. as per EN 1335-1 Class B (see page 2  
under Quality)

**Lumbar pump**

Lumbar pump is an optional extra on this model

**Neckrest Cassette**

If ordering a RH Logic 300 without neckrest you must  
add a neckrest cassette in order to equip the chair with  
a neckrest at a later stage

**Upholstery price group**

Customer fabric

Upholstery price group	Price
1	£ 623
2	£ 611
3	£ 616
4	£ 623
5	£ 646
6	£ 675
	£ 757

RH Logic 300 Comfort

Art. no 3343

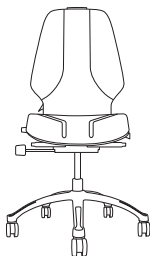

**RH Logic 300 Comfort**

Extra padding with improved ventilation in seat- and  
backpad

Backrest RH300: width 440 mm, height 510 mm

Seat RH400: width 465 mm, depth 475 mm  
(seatslide 60 mm)

Seat height: 410-530 mm (4Q)

Base in graphite aluminium (5X) and castors for  
carpeted floors (Ø 65mm)

Dimension spec. as per EN 1335-1 Class B (see page 2  
under Quality)

**Lumbar pump**

Lumbar pump is an optional extra on this model

**Neckrest Cassette** If ordering a RH Logic 300 without  
neckrest you must add a neckrest cassette in order to  
equip the chair with a neckrest at a later stage

**Upholstery price group**

Customer fabric

Upholstery price group	Price
1	£ 665
2	£ 658
3	£ 665
4	£ 688
5	£ 717
6	£ 799

RH Logic 300 24 hr

Art. no 3349

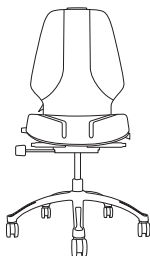

**RH Logic 300 24 hr**

Extra padding with improved ventilation in seat- and  
backpad This model is tested and approved for control  
room use

Backrest RH300: width 440 mm, height 510 mm

Seat RH400: width 465 mm, depth 475 mm  
(seatslide 60 mm)

Seat height: 410-530 mm (4Q)

Base in graphite aluminium (5X) and castors for  
carpeted floors (Ø 65mm)

Dimension spec. as per EN 1335-1 Class B (see page 2  
under Quality)

**Lumbar pump**

Lumbar pump is an optional extra on this model

**Neckrest Cassette**

If ordering a RH Logic 300 without neckrest you must  
add a neckrest cassette in order to equip the chair with  
a neckrest at a later stage

**Upholstery price group**

Fabric 24/7

Leather

Upholstery price group	Price
Fabric 24/7	£ 665
Leather	£ 799

RH Logic 300 Elegance

Art. no 3347

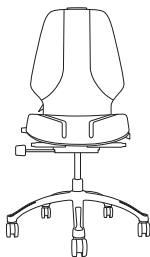

**RH Logic 300 Elegance**

Including upholstered backshell

Backrest RH300: width 440 mm, height 510 mm

Seat RH400: width 465 mm, depth 475 mm  
(seatslide 60 mm)

Seat height: 410-530 mm (4Q)

Base in graphite aluminium (5X) and castors for  
carpeted floors (Ø 65mm)

Dimension spec. as per EN 1335-1 Class B (see page 2  
under Quality)

**Lumbar pump**

Lumbar pump is an optional extra on this model

**Neckrest Cassette**

If ordering a RH Logic 300 without neckrest you must  
add a neckrest cassette in order to equip the chair with  
a neckrest at a later stage

**Upholstery price group**

Customer fabric

Upholstery price group	Price
1	£ 684
2	£ 666
3	£ 675
4	£ 684
5	£ 714
6	£ 757
	£ 899

Accessories/Options RH Logic 300

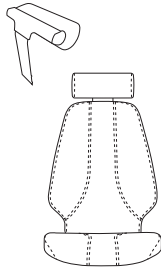

	<b>Art. no</b>	<b>Price</b>
<b>Neckrest</b> RH 400 - Fabric/C.O.M Height and depth adjustable	15022	£ 48
RH 400 - Leather Height and depth adjustable	15032	£ 75
<b>Neckrest Cassette</b> To enable a neck-rest to be fitted at a later stage, you "must" add a neck rest cassette.	<b>Art. no</b> 15041	<b>Price</b> £ 4
<b>Decorative stitching</b>	<b>Art. no</b> 905005	<b>Price</b> £ 47

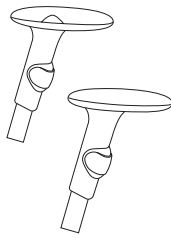

	<b>Art. no</b>		<b>Price/pair</b>
<b>Armrest</b> 8S Adjustable in height and width. Rotating. Armrest height above seat 215-295 mm	8300150	Grey	£ 80
	8300150-02	Black	£ 80
8S Class A Adjustable in height and width. Rotating. Armrest height above seat 200-280 mm	8300100	Grey	£ 80
	8300100-02	Black	£ 80
8E Adjustable in height, depth and width. Armrest height above seat 215-295 mm	8700300	Grey	£ 84
	8700300-02	Black	£ 84
	8700200	Upholstery leather	£ 122
	8700200-02	Black/uph. leather	£ 122
8E Class A Adjustable in height, depth and width. Armrest height above seat 200-280 mm	87000	Grey	£ 84
	87000-02	Black	£ 84
	8700250	Upholstery leather	£ 122
	8700250-02	Black/Upholstery leather	£ 122

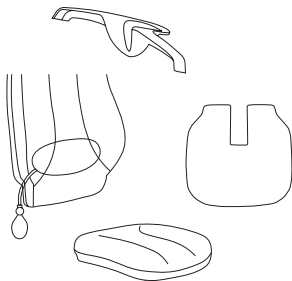

<b>Coat hanger</b>	<b>Art. no</b> 111050		<b>Price</b> £ 28
<b>Lumbar pump</b>	<b>Art. no</b> 150011		<b>Price</b> £ 34
<b>XL seat</b> Art. no. for RH Logic 300 with XL seat Width 485 mm, depth 515 mm, seatslide 60 mm	<b>Art. no</b> 3360 3363 3369 3367	Standard Comfort 24 hr Elegance	<b>Price</b> £ 45 £ 45 £ 45 £ 45
<b>Coccyx</b> S15 Coccyx in the edge of seat	<b>Art. no</b> 750234		<b>Price</b> £ 47

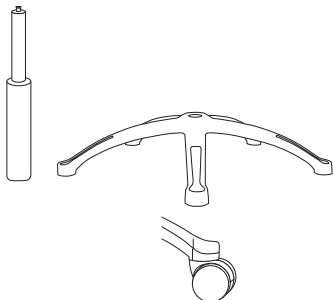

<b>Gas stem</b> B For seat height 480-610 mm	<b>Art. no</b> 520020-01		<b>Price</b> £ 0
B Black For seat height 480-610 mm	520020-02		£ 0
B Chrome For seat height 480-610 mm	520020-03		£ 0
4Q Black For seat height 410-530 mm	520001-05		£ 0
<b>Base</b> 5X - Polished Ø660 mm, 5-star, polished aluminium	<b>Art. no</b> 510013-03		<b>Price</b> £ 37
5X - Black Ø660 mm, 5-star, black aluminium	510013-02		£ 0
<b>Castor</b> For hard floors Ø 65 mm	<b>Art. no</b> 125177	Set of 5	<b>Price</b> £ 0

## RH Logic 400

Art. no 3550

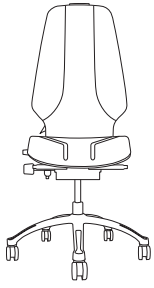
**RH Logic 400**

**Backrest RH400 incl. lumbar pump:**  
width 440 mm, height 620 mm  
**Seat RH400:** width 465 mm, depth 475 mm  
(seatslide 60 mm)  
**Seat height:** 410–530 mm (4Q)  
**Base in graphite aluminium (5X) and castors for  
carpeted floors (Ø 65mm)**

Dimension spec. as per EN 1335-1 Class B (see page 2  
under Quality)

**Upholstery price group**

Customer fabric

**Price**

£ 714

1 £ 700

2 £ 706

3 £ 714

4 £ 743

5 £ 774

6 £ 869

## RH Logic 400 Comfort

Art. no 3553

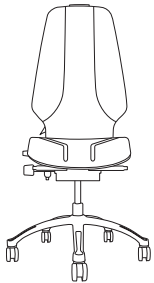
**RH Logic 400 Comfort**

**Extra padding with improved ventilation in seat- and  
backpad Backrest RH400 incl. lumbar pump:**  
width 440 mm, height 620 mm  
**Seat RH400:** width 465 mm, depth 475 mm  
(seatslide 60 mm)  
**Seat height:** 410–530 mm (4Q)  
**Base in graphite aluminium (5X) and castors for  
carpeted floors (Ø 65mm)**

Dimension spec. as per EN 1335-1 Class B (see page 2  
under Quality)

**Upholstery price group**

Customer fabric

**Price**

£ 761

1 £ 747

2 £ 753

3 £ 761

4 £ 790

5 £ 821

6 £ 916

## RH Logic 400 24 hr

Art. no 3559

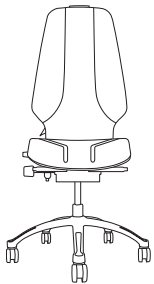
**RH Logic 400 24 hr**

**Extra padding with improved ventilation in seat- and  
backpad This model is tested and approved for control  
room use Backrest RH400 incl. lumbar pump:**  
width 440 mm, height 620 mm  
**Seat RH400:** width 465 mm, depth 475 mm  
(seatslide 60 mm)  
**Seat height:** 410–530 mm (4Q)  
**Base in graphite aluminium (5X) and castors for  
carpeted floors (Ø 65mm)**

Dimension spec. as per EN 1335-1 Class B (see page 2  
under Quality)

**Upholstery price group**

Fabric 24/7

**Price**

£ 761

Leather

£ 916

## RH Logic 400 Elegance

Art. no 3557

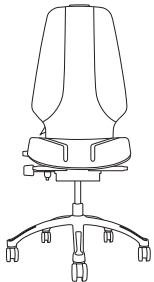
**RH Logic 400 Elegance**

**Including upholstered backshell Backrest RH400 incl.  
lumbar pump:** width 440 mm, height 620 mm  
**Seat RH400:** width 465 mm, depth 475 mm  
(seatslide 60 mm)  
**Seat height:** 410–530 mm (4Q)  
**Base in graphite aluminium (5X) and castors for  
carpeted floors (Ø 65mm)**

Dimension spec. as per EN 1335-1 Class B (see page 2  
under Quality)

**Upholstery price group**

Customer fabric

**Price**

£ 791

1 £ 769

2 £ 780

3 £ 791

4 £ 827

5 £ 875

6 £ 1045

Accessories/Options RH Logic 400

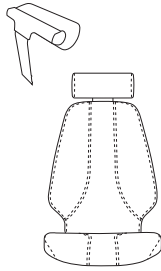

	Art. no	Price
<b>Neckrest</b>		
RH 400 - Fabric/C.O.M Height and depth adjustable	15022	£ 48
RH 400 - Leather Height and depth adjustable	15032	£ 75
<b>Decorative stitching</b>	<b>Art. no</b>	<b>Price</b>
	905005	£ 47

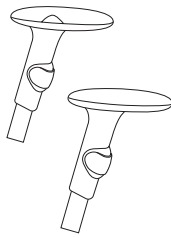

	Art. no		Price/pair
<b>Armrest</b>			
8S	8300150	Grey	£ 80
Adjustable in height and width. Rotating. Armrest height above seat 215-295 mm	8300150-02	Black	£ 80
8S Class A	8300100	Grey	£ 80
Adjustable in height and width. Rotating. Armrest height above seat 200-280 mm	8300100-02	Black	£ 80
8E	8700300	Grey	£ 84
Adjustable in height, depth and width. Armrest height above seat 215-295 mm	8700300-02	Black	£ 84
	8700200	Upholstery leather	£ 122
	8700200-02	Black/Upholstery leather	£ 122
8E Class A	87000	Grey	£ 84
Adjustable in height, depth and width. Armrest height above seat 200-280 mm	87000-02	Black	£ 84
	8700250	Upholstery leather	£ 122
	8700250-02	Black/Upholstery leather	£ 122

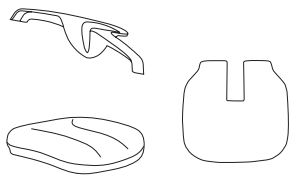

<b>Coat hanger</b>	<b>Art. no</b>		<b>Price</b>
	111050		£ 28
<b>XL seat</b>	<b>Art. no</b>		<b>Price</b>
Art. no. for RH Logic 400 with XL seat Width 485 mm, depth 515 mm, seatslide 60 mm	3560	Standard	£ 45
	3563	Comfort	£ 45
	3569	24 hr	£ 45
	3567	Elegance	£ 45
<b>Coccyx</b>	<b>Art. no</b>		<b>Price</b>
S15 Coccyx in the edge of seat	750234		£ 47

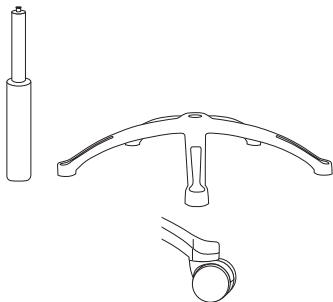

<b>Gas stem</b>	<b>Art. no</b>		<b>Price</b>
B	520020-01		£ 0
For seat height 480-610 mm			
B Black	520020-02		£ 0
For seat height 480-610 mm			
B Chrome	520020-03		£ 0
For seat height 480-610 mm			
4Q Black	520001-05		£ 0
For seat height 410-530 mm			
<b>Base</b>	<b>Art. no</b>		<b>Price</b>
5X Polished	510013-03		£ 37
Ø660 mm, 5-star, polished aluminium			
5X Black	510013-02		£ 0
Ø660 mm, 5-star, black aluminium			
<b>Castor</b>	<b>Art. no</b>		<b>Price</b>
For hard floors Ø 65 mm	125177	Set of 5	£ 0

## RH Logic 3

Art. no 2003

**RH Logic 3**

**Backrest RH3:** width 440 mm, height 450 mm  
**Seat RH2:** width 480 mm, depth 460 mm  
 (seatslide 60 mm)  
**Seat height:** 410 – 530 mm (4F Logic)  
**Base in grey lacquered aluminium (5L) and castors for carpeted floors**  
 Dimension spec. as per EN 1335-1 Class B (see page 2 under Quality)

**Upholstery price group**

Customer fabric

**Price**

£ 618  
 1 £ 610  
 2 £ 613  
 3 £ 618  
 4 £ 631  
 5 £ 649  
 6 £ 708

## RH Logic 3 with lumbar pump

Art. no 2003L

**RH Logic 3 with lumbar pump**

**Backrest RH3 incl. lumbar pump:**  
 width 440 mm, height 450 mm  
**Seat RH2:** width 480 mm, depth 460 mm  
 (seatslide 60 mm)  
**Seat height:** 410 – 530 mm (4F Logic)  
**Base in grey lacquered aluminium (5L) and castors for carpeted floors**  
 Dimension spec. as per EN 1335-1 Class B (see page 2 under Quality)

**Upholstery price group**

Customer fabric

**Price**

£ 652  
 1 £ 644  
 2 £ 647  
 3 £ 652  
 4 £ 665  
 5 £ 683  
 6 £ 742

## RH Logic 4

Art. no 2004

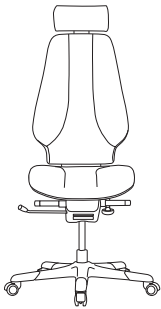
**RH Logic 4**

**Neckrest RH4**  
**Backrest RH4 incl. lumbar pump:**  
 width 450 mm, height 630 mm  
**Seat RH4:** width 470 mm, depth 480 mm  
 (seatslide 60 mm)  
**Seat height:** 435 – 550 mm (4F Logic)  
**Base in grey lacquered aluminium (5L) and castors for carpeted floors**  
 Dimension spec. as per EN 1335-1 Class B (see page 2 under Quality)

**Upholstery price group**

Customer fabric

**Price**

£ 810  
 1 £ 796  
 2 £ 802  
 3 £ 810  
 4 £ 839  
 5 £ 870  
 6 £ 992

## RH Logic 4 without neckrest

Art. no 2014

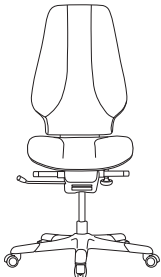
**RH Logic 4 without neckrest**

**Backrest RH4 incl. lumbar pump:**  
 width 450 mm, height 630 mm  
**Seat RH4:** width 470 mm, depth 480 mm  
 (seatslide 60 mm)  
**Seat height:** 435 – 550 mm (4F Logic)  
**Base in grey lacquered aluminium (5L) and castors for carpeted floors**  
 Dimension spec. as per EN 1335-1 Class B (see page 2 under Quality)

**Upholstery price group**

Customer fabric

**Price**

£ 765  
 1 £ 751  
 2 £ 757  
 3 £ 765  
 4 £ 794  
 5 £ 825  
 6 £ 920

Accessories/Options RH Logic 3-4

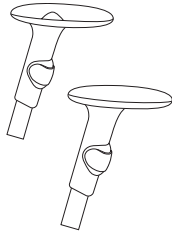

	<b>Art. no</b>		<b>Price/pair</b>
<b>Armrest</b> 8S Adjustable in height and width. Rotating. Armrest height above seat 215-295 mm	8300150	Grey	£ 80
	8300150-02	Black	£ 80
8S Class A Adjustable in height and width. Rotating. Armrest height above seat 200-280 mm	8300100	Grey	£ 80
	8300100-02	Black	£ 80
8E Adjustable in height, depth and width. Armrest height above seat 215-295 mm	8700300	Grey	£ 84
	8700300-02	Black	£ 84
	8700200	Upholstery leather	£ 122
	8700200-02	Black/Upholstery leather	£ 122
8E Class A Adjustable in height, depth and width. Armrest height above seat 200-280 mm	87000	Grey	£ 80
	87000-02	Black	£ 80
	8700250	Upholstery leather	£ 122
	8700250-02	Black/Upholstery leather	£ 122

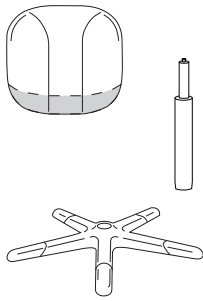

<b>Reinforced seat</b> Reinforced front edge seat RH2 (leather)	<b>Art. no</b>	<b>Price</b>
	99560	£ 23
<b>Gas stem</b> A For seat height 470-600 mm (RH Logic 3) For seat height 490-620 mm (RH Logic 4)	<b>Art. no</b>	<b>Price</b>
	520019	£ 0
<b>Base</b>	<b>Art. no</b>	<b>Price</b>
	5K Ø620 mm, black lacquered aluminium	£ 0
	5J Ø620 mm, polished aluminium	£ 36

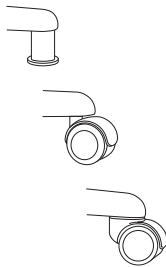

<b>Glide</b> 7K Plastic glide	<b>Art. no</b>		<b>Price</b>
	71810	Set of 5	£ 0
<b>Castor</b> For hard floors	<b>Art. no</b>		<b>Price</b>
	125108	Set of 5	£ 0
7G Locks automatically when seated	71400	Set of 5	£ 15

## RH Logic 4 Exclusiv

Art. no 2005

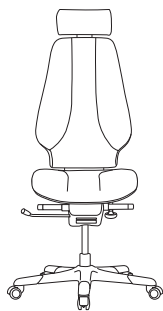

<b>RH Logic 4 Exclusiv</b>	<b>Upholstery price group</b>	<b>Price</b>
Extra padding and stitched seams	Customer fabric	£ 971
Neckrest RH4	1	£ 957
Backrest RH4 incl. lumbar pump: width 450 mm, height 630 mm	2	£ 963
Seat RH4: width 470 mm, depth 480 mm (seatslide 60 mm)	3	£ 971
Seat height: 435 – 550 mm (4F Logic)	4	£ 1000
Base in grey lacquered aluminium (5L) and castors for carpeted floors	5	£ 1031
	6	£ 1170

Dimension spec. as per EN 1335-1 Class B (see page 2 under Quality)

## RH Logic 4 Exclusiv without neckrest

Art. no 2015

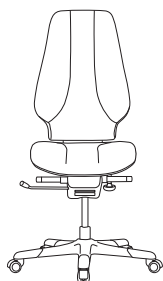

<b>RH Logic 4 Exclusiv without neckrest</b>	<b>Upholstery price group</b>	<b>Price</b>
Extra padding and stitched seams	Customer fabric	£ 926
Backrest RH4 incl. lumbar pump: width 450 mm, height 630 mm	1	£ 912
Seat RH4: width 470 mm, depth 480 mm (seatslide 60 mm)	2	£ 918
Seat height: 435 – 550 mm (4F Logic)	3	£ 926
Base in grey lacquered aluminium (5L) and castors for carpeted floors	4	£ 955
	5	£ 986
	6	£ 1098

Dimension spec. as per EN 1335-1 Class B (see page 2 under Quality)

## RH Logic 4 Exclusiv Combi

Art. no 2006

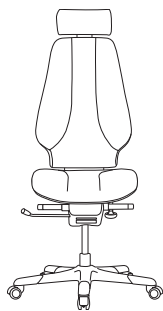

<b>RH Logic 4 Exclusiv Combi</b>	<b>Upholstery price group</b>	<b>Price</b>
Extra padding and stitched seams	Customer fabric	£ 1003
Seat and backrest in combined upholstery	1	£ 989
Neckrest RH4	2	£ 995
Backrest RH4 incl. lumbar pump: width 450 mm, height 630 mm	3	£ 1003
Seat RH4: width 470 mm, depth 480 mm (seatslide 60 mm)	4	£ 1032
Seat height: 435 – 550 mm (4F Logic)	5	£ 1063
Base in grey lacquered aluminium (5L) and castors for carpeted floors	6	£ 1202

Dimension spec. as per EN 1335-1 Class B (see page 2 under Quality)

## RH Logic 4 Elegance

Art. no 2007

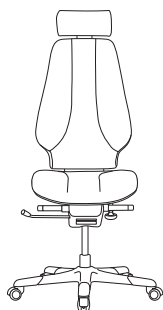

<b>RH Logic 4 Elegance</b>	<b>Upholstery price group</b>	<b>Price</b>
Extra padding and stitched seams including upholstered seat-/backshell in standard leather or Comfort fabric	Customer fabric	£ 1138
Neckrest RH4	1	£ 1124
Backrest RH4 incl. lumbar pump: width 450 mm, height 630 mm	2	£ 1130
Seat RH4: width 470 mm, depth 480 mm (seatslide 60 mm)	3	£ 1138
Seat height: 435 – 550 mm (4F Logic)	4	£ 1167
Base in grey lacquered aluminium (5L) and castors for carpeted floors	5	£ 1198
	6	£ 1337

Dimension spec. as per EN 1335-1 Class B (see page 2 under Quality)

## Accessories/Options RH Logic 4

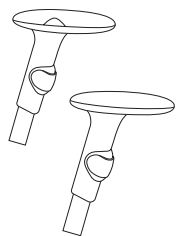

<b>Armrest</b>	<b>Art. no</b>		<b>Price/pair</b>
8S Adjustable in height and width. Rotating. Armrest height above seat 215-295 mm	8300150	Grey	£ 80
	8300150-02	Black	£ 80
8S Class A Adjustable in height and width. Rotating. Armrest height above seat 200-280 mm	8300100	Grey	£ 80
	8300100-02	Black	£ 80
8E Adjustable in height, depth and width. Armrest height above seat 215-295 mm	8700300	Grey	£ 84
	8700300-02	Black	£ 84
	8700200	Upholstery leather	£ 122
	8700200-02	Black/Upholstery leather	£ 122
8E Class A Adjustable in height, depth and width. Armrest height above seat 200-280 mm	87000	Grey	£ 84
	87000-02	Black	£ 84
	8700250	Upholstery leather	£ 122
	8700250-02	Black/Upholstery leather	£ 122

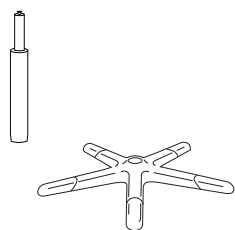

<b>Gas stem</b>	<b>Art. no</b>	<b>Price</b>
A For seat height 470-600 mm (RH Logic 3) For seat height 490-620 mm (RH Logic 4)	520019	£ 0
<b>Base</b>	<b>Art. no</b>	<b>Price</b>
5K Ø620 mm, black lacquered aluminium	56200	£ 0
5J Ø620 mm, polished aluminium	56100	£ 36

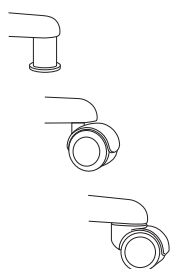

<b>Glidee</b>	<b>Art. no</b>	<b>Price</b>
7K Plastic glide	71810	£ 0
<b>Castor</b>	<b>Art. no</b>	<b>Price</b>
For hard floors	125108	£ 0
7G Locks automatically when seated	71400	£ 15

## RH Activ 200

Art. no 2772

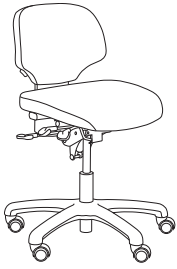
**RH Activ 200**

Backrest medium: width 370 mm, height 295 mm  
 Seat medium: width 440 mm, depth 430 mm  
 Seat height: 397-527 mm (B)  
 Base in black polyamide (5E) and castors for carpeted floors  
 Dimension spec. as per EN 1335-1 Class A

**Upholstery price group**

Customer fabric

**Price**

£ 339  
 1 £ 331  
 2 £ 333  
 3 £ 339  
 4 £ 345  
 5 £ 353  
 6 £ 397

## RH Activ 220

Art. no 2872

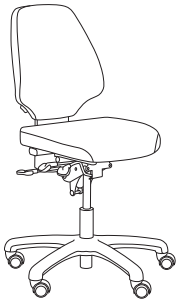
**RH Activ 220**

Backrest medium: width 370 mm, height 295 mm  
 Seat large: width 460 mm, depth 460 mm  
 Seat height: 397-527 mm (B)  
 Base in black polyamide (5E) and castors for carpeted floors  
 Dimension spec. as per EN 1335-1 Class A

**Upholstery price group**

Customer fabric

**Price**

£ 364  
 1 £ 356  
 2 £ 358  
 3 £ 364  
 4 £ 370  
 5 £ 378  
 6 £ 422

## RH Activ 202

Art. no 2782

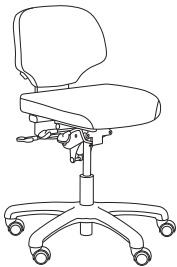
**RH Activ 202**

Backrest medium: width 370 mm, height 295 mm  
 Seat medium: width 440 mm, depth 430 mm  
 Seat height: 397-527 mm (B)  
 Base in black polyamide (5E) and castors for carpeted floors  
 Dimension spec. as per EN 1335-1 Class A

**Upholstery price group**

Customer fabric

**Price**

£ 358  
 1 £ 350  
 2 £ 352  
 3 £ 358  
 4 £ 364  
 5 £ 372  
 6 £ 416

## RH Activ 222

Art. no 2882

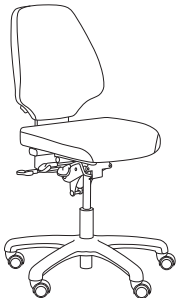
**RH Activ 222**

Backrest large: width 370 mm, height 430 mm  
 Seat large: width 460 mm, depth 460 mm  
 Seat height: 397-527 mm (B)  
 Base in black polyamide (5E) and castors for carpeted floors  
 Dimension spec. as per EN 1335-1 Class A

**Upholstery price group**

Customer fabric

**Price**

£ 383  
 1 £ 375  
 2 £ 377  
 3 £ 383  
 4 £ 389  
 5 £ 397  
 6 £ 441

## Accessories/Options RH Activ

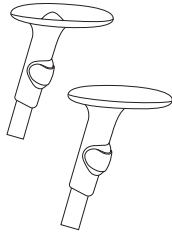

	<b>Art. no</b>		<b>Price/pair</b>
<b>Armrest</b>			
8S	8300150	Grey	£ 80
Adjustable in height and width. Rotating. Armrest height above seat 245–325 mm.	8300150-02	Black	£ 80
8S Class A	8300100	Grey	£ 80
Adjustable in height and width. Rotating. Armrest height above seat 215–295 mm	8300100-02	Black	£ 80
8E	8700300	Grey	£ 84
Adjustable in height, depth and width. Armrest height above seat 245–325 mm.	8700300-02	Black	£ 84
	8700200	Upholstery leather	£ 122
	8700200-02	Black/Upholstery leather	£ 122
8E Class A	87000	Grey	£ 84
Adjustable in height, depth and width. Armrest height above seat 200–280 mm	87000-02	Black	£ 84
	8700250	Upholstery leather	£ 122
	8700250-02	Black/Upholstery leather	£ 122

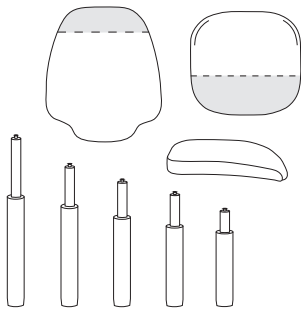

<b>Reinforced backpad</b>	<b>Art. no</b>	<b>Price</b>
Reinforced upper part backpad (leather)	99561	£ 23
<b>Reinforced seat</b>	<b>Art. no</b>	<b>Price</b>
Reinforced front edge seat (leather)	99560	£ 23
<b>Gas stem</b>	<b>Art. no</b>	<b>Price</b>
E*: For seat height: 605-855 mm	520022	£ 16
D: For seat height: 515-690 mm	520021	£ 5
A: For seat height: 442-578 mm	520019	£ 0
B Silver: For seat height: 397-527 mm	520020-01	£ 0
B Chrome: For seat height: 397-527 mm	520020-03	£ 0
4FL: For seat height: 375-465 mm	42000	£ 0
<b>Seat cashier</b>	<b>Art. no</b>	<b>Price</b>
Seat cashier medium (extra padding)	200020	£ 29

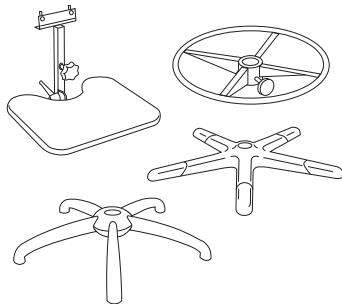

<b>Footring</b>	<b>Art. no</b>	<b>Price</b>
6F Ø455 mm	63100	£ 47
<b>Footplate</b>	<b>Art. no</b>	<b>Price</b>
6C Footplate of integral foam. Adjustable height and angle	65030	£ 84
<b>Base</b>	<b>Art. no</b>	<b>Price</b>
5L Ø620 mm, grey lacquered aluminium	5621000	£ 9
5K Ø620 mm, black lacquered aluminium	56200	£ 9
5J Ø620 mm, polished aluminium	56100	£ 45
5N** Ø540 mm, polished steel, for castors 7HN, 7D or 7G increases seat height 25 mm	56400	£ 15

\* RH Activ 220/222 only in combination with base 5L, 5K or 5J.

\*\* Only for RH Activ 200/202 with gas stem 4FL or B.

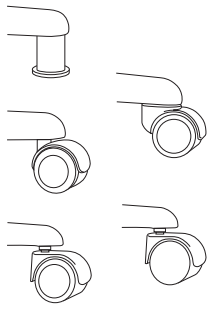

<b>Glide</b>	<b>Art. no</b>		<b>Price</b>
7K Plastic glide	71810	Set of 5	£ 0
<b>Castor</b>	<b>Art. no</b>		<b>Price</b>
For hard floors	125108	Set of 5	£ 0
7G Locks automatically when seated	71400	Set of 5	£ 15
7D For carpeted floors, for base 5N	7110050	Set of 5	£ 0
7HN For hard floors, for base 5N	7110060	Set of 5	£ 0



## Anatomical, innovative and functional performance

Precision ergonomics. Feature-rich functionality. Striking design deconstructed and reconstructed for performance. We engineer each RH Chair to targeted physiological and situational specifications. Our functions lead all our forms.



## Proven human performance at the heart of our identity

Our rigorous research and testing methodology validates how an RH chair enhances individual and organisational performance. Our RH Performance Studies have demonstrated an increase in the baseline performance of all organisations who have taken part. Now, that's Return on Investment.



## Performance and Quality are our Core

To increase customer performance we must consistently deliver products of unquestionable quality. We achieve this through the application of the exacting standards. Our 100% in-house, concept-to customer flow of production enables us to control every element – from design, product development and assembly to logistics to ensure high performance quality.



## Finding innovative ways for environmental performance

We keep our eye on the prize, the perpetual performance of your people as well as our planet. Our yield is recyclable, and even some biodegradable, products. The result, a minimised impact upon our global home.

## RH Support 4501

Art. no 4501

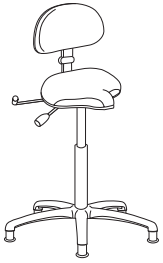
**RH Support 4501**

Backrest RH17: width 380 mm, height 230 mm  
 Seat RH8 Saddle: width 410 mm, depth 380 mm  
 Mechanism: 3G  
 Seat height: 565-810 mm (E)  
 Base in black polyamide (5E) and glides (7K)

**Seat height with gaslift:**

D 485-665 mm  
 A 415-545 mm  
 B 375-510 mm  
 4FL 345-430 mm

**Upholstery price group**

Customer fabric

**Price**

£ 285  
 1 £ 279  
 2 £ 281  
 3 £ 285  
 4 £ 291  
 5 £ 297  
 6 £ 339

## RH Support 4511

Art. no 4511

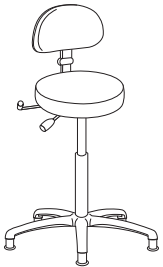
**RH Support 4511**

Backrest RH17: width 380 mm, height 230 mm  
 Seat RH9 Taburet: Ø350 mm  
 Mechanism: 3G  
 Seat height: 580-825 mm (E)  
 Base in black polyamide (5E) and glides (7K)

**Seat height with gaslift:**

D 500-680 mm  
 A 430-560 mm  
 B 390-525 mm  
 4FL 360-445 mm

**Upholstery price group**

Customer fabric

**Price**

£ 279  
 1 £ 273  
 2 £ 275  
 3 £ 279  
 4 £ 285  
 5 £ 291  
 6 £ 333

## RH Support 4521

Art. no 4521

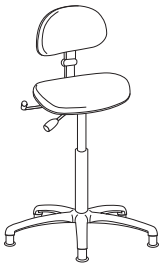
**RH Support 4521**

Backrest RH17: width 380 mm, height 230 mm  
 Seat RH7 Limpan: width 450 mm, depth 240 mm  
 Mechanism: 3G  
 Seat height: 565-810 mm (E)  
 Base in black polyamide (5E) and glides (7K)

**Seat height with gaslift:**

D 485-665 mm  
 A 415-545 mm  
 B 375-510 mm  
 4FL 345-430 mm

**Upholstery price group**

Customer fabric

**Price**

£ 277  
 1 £ 271  
 2 £ 273  
 3 £ 277  
 4 £ 283  
 5 £ 289  
 6 £ 331

## RH Support 4545

Art. no 4545

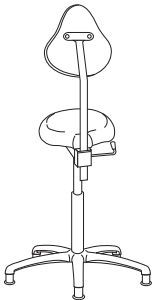
**RH Support 4545**

Backrest RH9 Alternativ: width 220 mm,  
 height 260 mm  
 Seat RH11 Alternativ: width 350 mm, depth 350 mm  
 Mechanism: 3G Alternativ  
 Seat height: 580-825 mm (E)  
 Base in black polyamide (5E) and glides (7K)

**Seat height with gaslift:**

D 500-680 mm  
 A 430-560 mm  
 B 390-525 mm  
 4FL 360-445 mm

**Upholstery price group**

Customer fabric

**Price**

£ 290  
 1 £ 284  
 2 £ 286  
 3 £ 290  
 4 £ 296  
 5 £ 302  
 6 £ 344

RH Support 4502

Art. no 4502

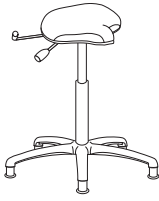

**RH Support 4502**  
 Seat RH8 Saddle: width 410 mm, depth 380 mm  
 Mechanism: 3H  
 Seat height: 565-810 mm (E)  
 Base in black polyamide (5E) and glides (7K)

Seat height with gaslift:  
 D 485-665 mm  
 A 415-545 mm  
 B 375-510 mm  
 4FL 345-430 mm

Upholstery price group	Price
Customer fabric	£ 206
1	£ 203
2	£ 204
3	£ 206
4	£ 209
5	£ 212
6	£ 232

RH Support 4512

Art. no 4512

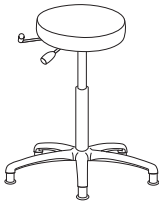

**RH Support 4512**  
 Seat RH9 Taburett: Ø350 mm  
 Mechanism: 3H  
 Seat height: 580-825 mm (E)  
 Base in black polyamide (5E) and glides (7K)

Seat height with gaslift:  
 D 500-680 mm  
 A 430-560 mm  
 B 390-525 mm  
 4FL 360-445 mm

Upholstery price group	Price
Customer fabric	£ 200
1	£ 197
2	£ 198
3	£ 200
4	£ 203
5	£ 206
6	£ 226

RH Support 4522

Art. no 4522

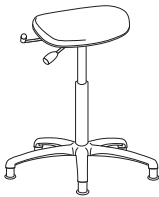

**RH Support 4522**  
 Seat RH7 Limpan: width 450 mm, depth 240 mm  
 Mechanism: 3H  
 Seat height: 565-810 mm (E)  
 Base in black polyamide (5E) and glides (7K)

Seat height with gaslift:  
 D 485-665 mm  
 A 415-545 mm  
 B 375-510 mm  
 4FL 345-430 mm

Upholstery price group	Price
Customer fabric	£ 198
1	£ 195
2	£ 196
3	£ 198
4	£ 201
5	£ 204
6	£ 224

RH Support 4532

Art. no 4532



**RH Support 4532**  
 Seat RH10 Froli: width 350 mm, depth 270 mm  
 Mechanism: 3H  
 Seat height: 580-825 mm (E)  
 Base in black polyamide (5E) and glides (7K)

Seat height with gaslift:  
 D 500-680 mm  
 A 430-560 mm  
 B 390-525 mm  
 4FL 360-445 mm

Upholstery price group	Price
Integral foam	£ 203

RH Support 4503

Art. no 4503



**RH Support 4503**  
 Seat RH8 Saddle: width 410 mm, depth 380 mm  
 Mechanism: 3I  
 Seat height: 540-785 mm (E)  
 Base in black polyamide (5E) and glides (7K)

Seat height with gaslift:  
 D 460-640 mm  
 A 390-520 mm  
 B 350-485 mm  
 4FL 320-405 mm

Upholstery price group	Price
Customer fabric	£ 178
1	£ 175
2	£ 176
3	£ 178
4	£ 181
5	£ 184
6	£ 204

RH Support 4513

Art. no 4513

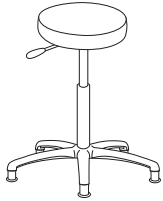

**RH Support 4513**  
 Seat RH9 Taburet: Ø350 mm  
 Mechanism: 3I  
 Seat height: 555-800 mm (E)  
 Base in black polyamide (5E) and glides (7K)

Seat height with gaslift:  
 D 475-655 mm  
 A 405-535 mm  
 B 365-500 mm  
 4FL 335-420 mm

Upholstery price group	Price
Customer fabric	£ 172
1	£ 169
2	£ 170
3	£ 172
4	£ 175
5	£ 178
6	£ 198

RH Support 4523

Art. no 4523



**RH Support 4523**  
 Seat RH7 Limpan: width 450 mm, depth 240 mm  
 Mechanism: 3I  
 Seat height: 540-785 mm (E)  
 Base in black polyamide (5E) and glides (7K)

Seat height with gaslift:  
 D 460-640 mm  
 A 390-520 mm  
 B 350-485 mm  
 4FL 320-405 mm

Upholstery price group	Price
Customer fabric	£ 170
1	£ 167
2	£ 168
3	£ 170
4	£ 173
5	£ 176
6	£ 196

RH Support 4533

Art. no 4533



**RH Support 4533**  
 Seat RH10 Froli: width 350 mm, depth 270 mm  
 Mechanism: 3I  
 Seat height: 555-800 mm (E)  
 Base in black polyamide (5E) and glides (7K)

Seat height with gaslift:  
 D 475-655 mm  
 A 405-535 mm  
 B 365-500 mm  
 4FL 335-420 mm

Upholstery price group	Price
Integral foam	£ 175

## Accessories/Options RH Support

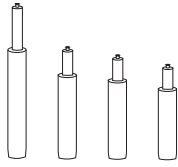
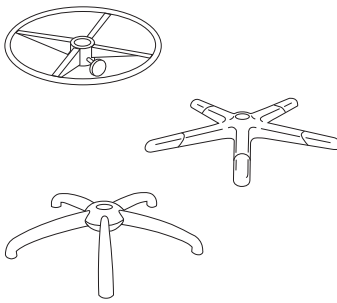
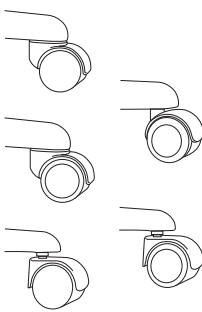
	<b>Gas stem</b>	<b>Art. no</b>	<b>Price</b>	
	For seatheight see each chairmodel D	520021	deduct £ 11	
	A	520019	deduct £ 16	
	B	520020-01	deduct £ 16	
	B Black	520020-02	deduct £ 16	
	B Chrome	520020-03	deduct £ 16	
	4FL	42000	deduct £ 16	
	<b>Footring</b>	<b>Art. no</b>	<b>Price</b>	
	6F Ø455 mm	63100	£ 47	
	<b>Base</b>	<b>Art. no</b>	<b>Price</b>	
	5L Ø620 mm, grey lacquered aluminium	5621000	£ 9	
	5K Ø620 mm, black lacquered aluminium	56200	£ 9	
	5J Ø620 mm, polished aluminium	56100	£ 45	
5N Ø540 mm, polished steel, for castors 7HN, 7D or 7G Increases seat height 25 mm	56400	£ 15		
	<b>Castor</b>	<b>Art. no</b>	<b>Price</b>	
	For carpeted floors	125104	Black	£ 5
	For hard floors	125108	Set of 5	£ 0
	7G Locks automatically when seated	71400	Set of 5	£ 15
	7D For carpeted floors, for base 5N	7110050	Set of 5	£ 0
	7HN For hard floors, for base 5N	7110060	Set of 5	£ 0

RH Logic 300 ESD

Art. no 3346

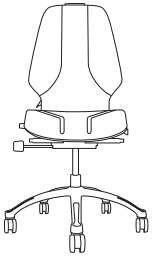

**RH Logic 300 ESD**

Including upholstered backshell

Backrest RH300: width 440 mm, height 510 mm  
Seat RH400: width 465 mm, depth 475 mm (seatslide 60 mm)

Seat height: 440-560 mm (4F Logic)

Base in black aluminium (5X black) and free wheeling ESD castors 7FM (metal)

Dimension spec. as per EN 1335-1 Class B (see page 2 under Quality)

**Upholstery price group**  
ESD

**Price**  
£ 772

RH Logic 400 ESD

Art. no 3556

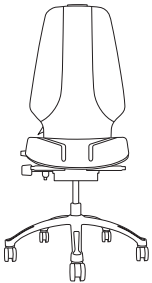

**RH Logic 400 ESD**

Including upholstered backshell

Backrest RH400 incl. lumbar pump: width 440 mm, height 620 mm

Seat RH400: width 465 mm, depth 475 mm (seatslide 60 mm)

Seat height: 440-560 mm (4F Logic)

Base in black aluminium (5X black) and free wheeling ESD castors 7FM (metal)

Dimension spec. as per EN 1335-1 Class B (see page 2 under Quality)

**Upholstery price group**  
ESD

**Price**  
£ 885

RH Extend 200 ESD

Art. no 6116

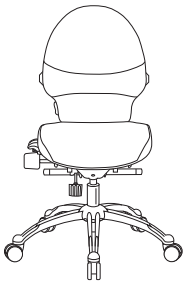

**RH Extend 200 ESD**

Backrest medium: width 440 mm, height 510 mm

Seat: width 460 mm, depth 470 mm (seatslide 60 mm)

Seat height: 440-560 mm (4F Logic)

Base in black lacquered aluminium (5M black) and castors for carpeted floors (Ø 65mm)

Dimension spec. as per EN 1335-1 Class B (see page 2 under Quality)

**Upholstery price group**  
ESD

**Price**  
£ 573

RH Extend 220 ESD

Art. no 6216

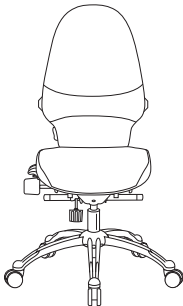

**RH Extend 220 ESD**

Backrest large: width 440 mm, height 620 mm

Seat: width 460 mm, depth 470 mm (seatslide 60 mm)

Seat height: 440-560 mm (4F Logic)



Base in black lacquered aluminium (5M black) and castors for carpeted floors (Ø 65mm)

Dimension spec. as per EN 1335-1 Class B (see page 2 under Quality)

**Upholstery price group**  
ESD

**Price**  
£ 622

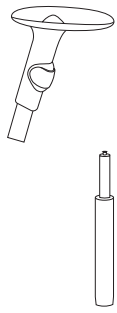
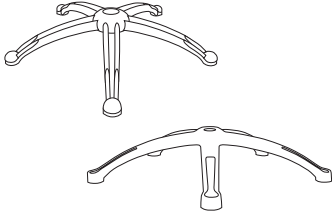
Accessories/Options RH Extend, RH Logic 300/400 ESD

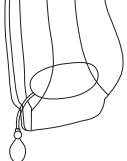
	<p><b>Armrest</b> 8E ESD Adjustable in height, depth and width Armrest height above seat 215-295 mm</p> <p><b>Gas stem</b> B Chrome (only for RH Logic 400/300 ESD)</p>	<p><b>Art. no</b> 8700330</p>	<p><b>Price/pair</b> £ 110</p>
	<p><b>Base</b> 5MP Ø 660 mm, polished aluminium (only for RH Extend ESD)</p> <p>5X Ø660 mm, 5-star, polished aluminium (only for RH Logic 300/400 ESD)</p>	<p><b>Art. no</b> 5203000-01</p>	<p><b>Price</b> £ 37</p>
	<p><b>Castor</b> 7HF ESD, for hard floors</p>	<p><b>Art. no</b> 71920</p>	<p><b>Price</b> deduct £ 20</p>
	<p><b>Lumbar pump</b> Lumbar pump (only for RH Logic 300 ESD)</p>	<p><b>Art. no</b> 150011</p>	<p><b>Price</b> £ 34</p>

## RH Activ 200 ESD

Art. no 2776

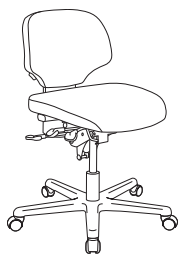
**RH Activ 200 ESD**

Backrest medium ESD: width 370 mm, height 295 mm

Seat medium: width 440 mm, depth 430 mm

Seat height: 397-527 mm (B)

Base in black aluminium (5K) and free wheeling ESD castors 7FM (metal)

Dimension spec. as per EN 1335-1 Class A (see page 2 under Quality)

**Upholstery price group**

ESD

**Price**

£ 433

## RH Activ 220 ESD

Art. no 2876

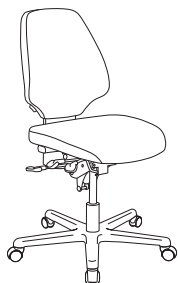
**RH Activ 220 ESD**

Backrest large ESD: width 370 mm, height 430 mm

Seat medium: width 440 mm, depth 430 mm

Seat height: 397-527 mm (B)

Base in black aluminium (5K) and free wheeling ESD castors 7FM (metal)

Dimension spec. as per EN 1335-1 Class A (see page 2 under Quality)

**Upholstery price group**

ESD

**Price**

£ 459

## RH Activ 222 ESD

Art. no 2886

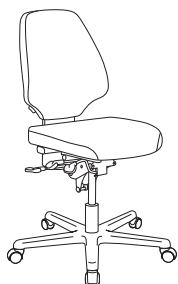
**RH Activ 222 ESD**

Backrest large ESD: width 370 mm, height 430 mm

Seat large: width 460 mm, depth 460 mm

Seat height: 397-527 mm (B)

Base in black aluminium (5K) and free wheeling ESD castors 7FM (metal)

Dimension spec. as per EN 1335-1 Class A (see page 2 under Quality)

**Upholstery price group**

ESD

**Price**

£ 478

## Accessories/Options RH Activ ESD

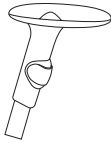

**Armrest**  
 8E ESD  
 Adjustable in height, depth and width  
 Armrest height above seat: 245-325 mm

**Art. no**  
 8700330

**Price/pair**  
 £ 110

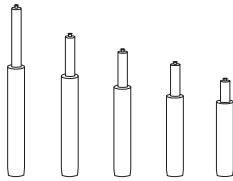

**Gas stem**  
 E  
 For seat height: 605-855 mm  
 D  
 For seat height: 515-690 mm  
 A  
 For seat height: 442-578 mm  
 4FL  
 For seat height: 375-465 mm

**Art. no**  
 520022  
 520021  
 520019  
 42000

**Price**  
 £ 16  
 £ 5  
 £ 0  
 £ 0

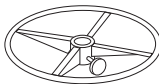

**Footring**  
 6F  
 Ø455 mm

**Base**  
 5J  
 Ø620 mm, polished aluminium

**Art. no**  
 63100

**Price**  
 £ 47

**Art. no**  
 56100

**Price**  
 £ 36



**Castor**  
 7HF  
 ESD, for hard floors

**Art. no**  
 71920

**Price**  
 deduct £ 20

## RH Support ESD 7

Art. no 4526

**RH Support ESD 7**

Seat RH7 Limpan: width 450 mm, depth 240 mm

Mechanism: 3H

Seat height: approx. 565-810 mm (E)

Base in black aluminium (5K) and free wheeling

ESD castors 7FM (metal)

**Seat height with gaslift:**

D 485-665 mm

A 415-545 mm

B 375-510 mm

**Upholstery price group**

ESD

**Price**

£ 262

## RH Support ESD 8

Art. no 4506

**RH Support ESD 8**

Seat RH8 Saddle: width 410 mm, depth 300 mm

Mechanism: 3H

Seat height: approx. 565-810 mm (E)

Base in black aluminium (5K) and free wheeling

ESD castors 7FM (metal)

**Seat height with gaslift:**

D 485-665 mm

A 415-545 mm

B 375-510 mm

**Upholstery price group**

ESD

**Price**

£ 271

## RH Support ESD 9

Art. no 4516

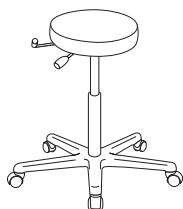
**RH Support ESD 9**

Seat RH9 Taburett: Ø350 mm

Mechanism: 3H

Seat height: approx. 580-825 mm (E)

Base in black aluminium (5K) and free wheeling

ESD castors 7FM (metal)

**Seat height with gaslift:**

D 500-680 mm

A 430-560 mm

B 390-525 mm

**Upholstery price group**

ESD

**Price**

£ 264

## Accessories/Options RH Support ESD

---

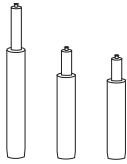

<b>Gas stem</b>	<b>Art. no</b>	<b>Price</b>
For seat height see each chair model D	520021	deduct £ 11
A	520019	deduct £ 16
B Chrome	520020-03	deduct £ 16

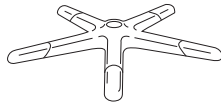
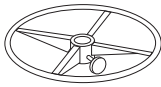

<b>Footring</b>	<b>Art. no</b>	<b>Price</b>
6F Ø455 mm, polished footring	63100	£ 47
<b>Base</b>	<b>Art. no</b>	<b>Price</b>
5J Ø620 mm, polished aluminium	56100	£ 36



<b>Castor</b>	<b>Art. no</b>	<b>Price</b>
7HF Ø620 mm, polished aluminium	71920	Set of 5 deduct £ 20

RH Activ 200 ESD Cleanroom

Art. no 2774

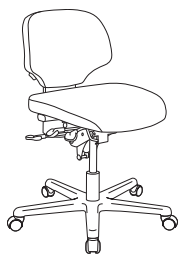

**RH Activ 200 ESD Cleanroom**

**Backrest medium ESD Cleanroom:** width 370 mm,

height 295 mm

**Seat medium Cleanroom:** width 440 mm,

depth 430 mm

**Seat height:** 397-527 mm (B)

**Base in black aluminium (5K) and free wheeling ESD castors 7FM (metal)**

**Dimension spec. as per EN 1335-1 Class A (see page 2 under Quality)**

**Upholstery price group**

ESD Cleanroom

**Price**

£ 510

RH Activ 220 ESD Cleanroom

Art. no 2874

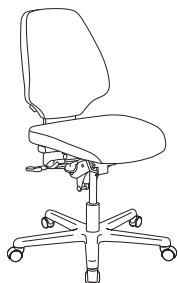

**RH Activ 220 ESD Cleanroom**

**Backrest large ESD Cleanroom:** width 370 mm,

height 430 mm

**Seat medium Cleanroom:** width 440 mm,

depth 430 mm

**Seat height:** 397-527 mm (B)

**Base in black aluminium (5K) and free wheeling ESD castors 7FM (metal)**

**Dimension spec. as per EN 1335-1 Class A (see page 2 under Quality)**

**Upholstery price group**

ESD Cleanroom

**Price**

£ 536

## Accessories/Options RH Activ ESD Cleanroom

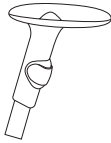

**Armrest**  
8E ESD  
Adjustable in height, depth and width.  
Armrest height above seat: 245-325 mm

**Art. no**  
8700330

**Price/pair**  
£ 110

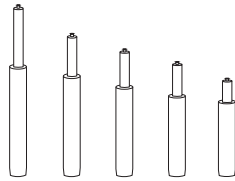

**Gas stem**  
E  
For seat height: 605-855 mm  
D  
For seat height: 515-690 mm  
A  
For seat height: 442-578 mm  
4FL  
For seat height: 375-465 mm

**Art. no**  
520022  
520021  
520019  
42000

**Price**  
£ 16  
£ 5  
£ 0  
£ 0

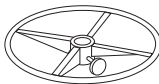

**Footring**  
6F  
Ø455 mm, polished footring

**Base**  
5J  
Ø620 mm, polished aluminium

**Art. no**  
63100

**Price**  
£ 47

**Art. no**  
56100

**Price**  
£ 36



**Castor**  
7HF  
ESD, for hard floors

**Art. no**  
71920

Set of 5

**Price**  
deduct £ 20

RH Activ 200 Cleanroom

Art. no 2773

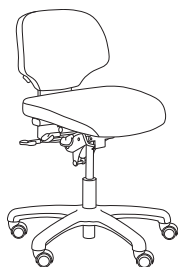

**RH Activ 200 Cleanroom**  
**Backrest medium Cleanroom:** width 370 mm,  
height 295 mm  
**Seat medium Cleanroom:** width 440 mm,  
depth 430 mm  
**Seat height:** 397-527 mm(B)  
**Base in black polyamide (5E) and castors for hard  
floors**  
**Dimension spec. as per EN 1335-1 Class A (see page 2  
under Quality)**

**Upholstery price group**  
Cleanroom

**Price**  
£ 422

RH Activ 220 Cleanroom

Art. no 2873

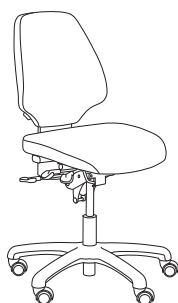

**RH Activ 220 Cleanroom**  
**Backrest large Cleanroom:** width 370 mm,  
height 430 mm  
**Seat medium Cleanroom:** width 440 mm,  
depth 430 mm  
**Seat height:** 397-527 mm (B)  
**Base in black polyamide (5E) and castors for hard  
floors**  
**Dimension spec. as per EN 1335-1 Class A (see page 2  
under Quality)**

**Upholstery price group**  
Cleanroom

**Price**  
£ 447

## Accessories/Options RH Activ Cleanroom

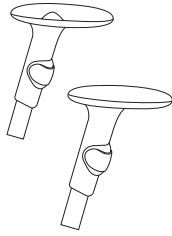

Armrest	Art. no		Price/pair
8S	8300150	Grey	£ 80
Adjustable in height and width. Rotating. Armrest height above seat: 245-326 mm	8300150-02	Black	£ 80
8S Class A	8300100	Grey	£ 80
Adjustable in height and width. Rotating. Armrest height above seat: 215-295 mm	8300100-02	Black	£ 80
8E	8700300	Grey	£ 84
Adjustable in height, depth and width. Armrest height above seat: 245-325 mm	8700300-02	Black	£ 84
	8700200	Upholstery leather	£ 122
	8700200-02	Black/Upholstery leather	£ 122
8E Class A	87000	Grey	£ 84
Adjustable in height, depth and width. Armrest height above seat: 215-295 mm	87000-02	Black	£ 84
	8700250	Upholstery leather	£ 122
	8700250-02	Black/Upholstery leather	£ 122

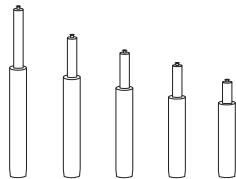

Gas stem	Art. no	Price
E*	520022	£ 16
For seat height: 605-855 mm		
D	520021	£ 5
For seat height: 515-690 mm		
A	520019	£ 0
For seat height: 442-578 mm		
B Silver	520020-01	£ 0
For seat height: 397-527 mm		
B Chrome	520020-03	£ 0
For seat height: 397-527 mm		
4FL	42000	£ 0
For seat height: 375-465 mm		

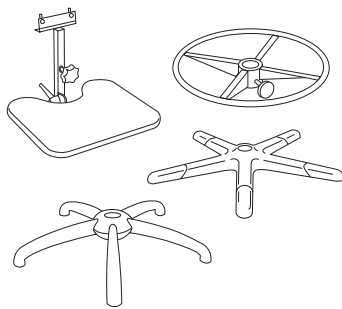

Footring	Art. no	Price
6F	63100	£ 47
Ø455 mm, polished footring		
Footplate	Art. no	Price
6C	65030	£ 84
Footplate of integral foam. Adjustable height and angle		
Base	Art. no	Price
5L	5621000	£ 9
Ø620 mm, grey lacquered aluminium		
5K	56200	£ 9
Ø620 mm, black lacquered aluminium		
5J	56100	£ 45
Ø620 mm, polished aluminium		
5N**	56400	£ 15
Ø540 mm, polished steel, for castors 7HN, 7D or 7G. Increases seat height 25 mm		

\* RH Activ 220 Cleanroom only in combination with base 5L, 5K or 5J.  
\*\* Only for RH Activ 200 Cleanroom with gas stem 4FL or B

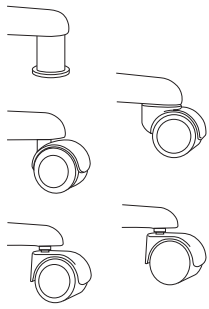

	<b>Art. no</b>	<b>Price</b>
<b>Glide</b> 7K Plastic glide	71810	£ 0
<b>Castor</b> For carpeted floors	<b>Art. no</b> 125104	<b>Price</b> Set of 5 £ 0
7G Locks automatically when seated	71400	Set of 5 £ 15
7D For carpeted floors, for base 5N	7110050	Set of 5 £ 0
7HN For hard floors, for base 5N	7110060	Set of 5 £ 0

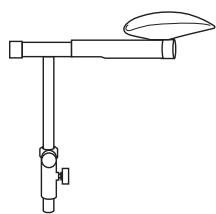
**8R Relax**

Flexible arm support. For support and relief of the arm and wrist when operating the mouse or keyboard.  
Adjustable in height and width.  
Two dimensional movement.

**Art. no**

82000 Each  
82010 Pair

**Price**

£ 91  
£ 182

## 8R3D Relax

## Art. no 84000/84010

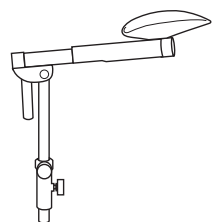
**8R3D Relax**

Flexible arm support. For support and relief of the arm and wrist when operating the mouse or keyboard.  
Adjustable in height and width.  
Three dimensional movement.

**Art. no**

84000 Each  
84010 Pair

**Price**

£ 114  
£ 228

## Armrest

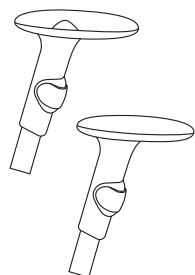

The flexible arm supports can be complemented with our other armrests, there are armrests in right and left designs respectively. For technical information, please refer to model.

Armrest	Art. no	Black		Price/each
		Art. no	Price/each	
8E right	8700320	8700320-02	£ 42	
8E left	8700310	8700310-02	£ 42	
8E right, upholstered	8700210	8700210-02	£ 61	
8E left, upholstered	8700220	8700220-02	£ 61	
8E Class A right	87001	87001-02	£ 42	
8E Class A left	87002	87002-02	£ 42	
8E Class A right, upholstered	8700260	8700260-02	£ 61	
8E Class A left, upholstered	8700270	8700270-02	£ 61	
8S right	8300160	8300160-02	£ 40	
8S left	8300170	8300170-02	£ 40	
8S Class A, right	8300110	8300110-02	£ 40	
8S Class A, left	8300120	8300120-02	£ 40	

## Replacement pads for backrests and seats

	Art. no	C.O.M.	Group 1	Group 2	Group 3	Group 4	Group 5	Group 6
<b>Backrest pads</b>								
RH 17	111002	£ 41	£ 38	£ 40	£ 41	£ 46	£ 51	£ 77
Activ Medium	100036	£ 50	£ 45	£ 46	£ 50	£ 54	£ 59	£ 88
Activ Large	100034	£ 78	£ 73	£ 74	£ 78	£ 82	£ 87	£ 116
Extend Medium	1850026	£ 67	£ 63	£ 65	£ 67	£ 77	£ 98	£ 126
Extend Large	1860026	£ 89	£ 85	£ 87	£ 89	£ 99	£ 120	£ 175
RH300	10031	£ 78	£ 72	£ 75	£ 78	£ 94	£ 110	£ 159
RH300 Comfort/24 hr*	10032	£ 117	£ 111	£ 114	£ 117	£ 133	£ 149	£ 198
RH400	10001	£ 167	£ 158	£ 162	£ 167	£ 188	£ 207	£ 265
RH400 Comfort/24 hr*	10021	£ 217	£ 208	£ 212	£ 217	£ 238	£ 257	£ 315
<b>Seat pads</b>								
Activ Medium**	200018	£ 80	£ 75	£ 76	£ 80	£ 84	£ 89	£ 118
Activ Large**	200019	£ 105	£ 100	£ 101	£ 105	£ 109	£ 114	£ 143
Activ cashier Medium**	200020	£ 118	£ 113	£ 114	£ 118	£ 122	£ 127	£ 156
Extend	2850025	£ 106	£ 102	£ 104	£ 106	£ 116	£ 137	£ 165
RH400	20002	£ 116	£ 108	£ 112	£ 116	£ 134	£ 150	£ 201
RH400 Comfort/24 hr*	20022	£ 146	£ 138	£ 142	£ 146	£ 164	£ 180	£ 231
RH400 XL	20037	£ 196	£ 188	£ 192	£ 196	£ 214	£ 230	£ 281
RH400 XL Comfort/24 hr*	20038	£ 226	£ 218	£ 222	£ 226	£ 244	£ 260	£ 311

\* Pads 24 hr: available in 24/7 fabric and leather only.

\*\* Complete seat.







## Fabric requirement

Fabric requirements for customer fabrics; width 150 cm (130 cm). NB! Allow for fabric manufacturers pattern-matching.

Quantity	1 unit	2 units	3 units	4 units	6 units	8 units	10 units	leather 1 unit*
RH Extend 100/200	65 (65) cm	105 (115) cm	145 (165) cm	195 (210) cm	300 (335) cm	400 (440) cm	470 (535) cm	
RH Extend 120/220	65 (90) cm	105 (140) cm	155 (190) cm	215 (240) cm	310 (370) cm	420 (480) cm	530 (600) cm	
RH Logic 300 with neckrest	80 (100) cm	150 (170) cm	220 (250) cm	300 (340) cm	450 (500) cm	590 (660) cm	730 (840) cm	2 m <sup>2</sup>
RH Logic 300 without neckrest	80 (90) cm	140 (150) cm	200 (230) cm	260 (300) cm	400 (440) cm	520 (590) cm	650 (740) cm	2 m <sup>2</sup>
RH Logic 300 Elegance with neckrest	100 (115) cm	190 (220) cm	280 (320) cm	380 (430) cm	580 (650) cm	770 (870) cm	950 (1080) cm	2,5 m <sup>2</sup>
RH Logic 300 Elegance without neckrest	100 (110) cm	170 (200) cm	250 (300) cm	340 (400) cm	520 (590) cm	700 (790) cm	870 (1000) cm	2,5 m <sup>2</sup>
RH Logic 300 XL with neckrest	100 (100) cm	160 (190) cm	240 (280) cm	320 (370) cm	470 (550) cm	630 (740) cm	800 (920) cm	2 m <sup>2</sup>
RH Logic 300 XL without neckrest	100 (100) cm	150 (180) cm	210 (250) cm	280 (330) cm	420 (490) cm	560 (650) cm	710 (820) cm	2 m <sup>2</sup>
RH Logic 300 XL Elegance with neckrest	110 (120) cm	200 (230) cm	320 (370) cm	410 (460) cm	620 (690) cm	820 (940) cm	1020 (1170) cm	2,5 m <sup>2</sup>
RH Logic 300 XL Elegance without neckrest	100 (120) cm	180 (230) cm	280 (370) cm	370 (460) cm	550 (690) cm	750 (940) cm	940 (1170) cm	2,5 m <sup>2</sup>
RH Logic 400 with neckrest	90 (115) cm	160 (190) cm	240 (280) cm	320 (380) cm	480 (560) cm	640 (740) cm	790 (930) cm	2 m <sup>2</sup>
RH Logic 400 without neckrest	90 (115) cm	150 (180) cm	210 (280) cm	290 (360) cm	430 (540) cm	580 (730) cm	710 (920) cm	2 m <sup>2</sup>
RH Logic 400 Elegance with neckrest	110 (130) cm	210 (260) cm	310 (390) cm	420 (520) cm	630 (760) cm	830 (1000) cm	1040 (1280) cm	2,5 m <sup>2</sup>
RH Logic 400 Elegance without neckrest	110 (130) cm	200 (260) cm	290 (390) cm	380 (520) cm	590 (760) cm	780 (1000) cm	980 (1280) cm	2,5 m <sup>2</sup>
RH Logic 400 XL with neckrest	100 (120) cm	170 (230) cm	260 (340) cm	350 (450) cm	520 (670) cm	680 (890) cm	850 (1110) cm	2 m <sup>2</sup>
RH Logic 400 XL without neckrest	100 (120) cm	150 (230) cm	240 (340) cm	320 (450) cm	470 (670) cm	610 (890) cm	780 (1110) cm	2 m <sup>2</sup>
RH Logic 400 XL Elegance with neckrest	120 (160) cm	220 (300) cm	340 (450) cm	460 (600) cm	670 (900) cm	900 (1200) cm	1100 (1500) cm	2,5 m <sup>2</sup>
RH Logic 400 XL Elegance without neckrest	110 (160) cm	210 (300) cm	300 (450) cm	420 (600) cm	640 (900) cm	840 (1200) cm	1050 (1500) cm	2,5 m <sup>2</sup>
RH Logic 3	63 (63) cm	126 (126) cm	189 (189) cm					1,0 m <sup>2</sup>
RH Logic 4 with neckrest	90 (120) cm	155 (190) cm	225 (295) cm	290 (370) cm	450 (545) cm	595 (725) cm	750 (920) cm	1,8 m <sup>2</sup>
RH Logic 4 without neckrest	63 (120) cm	126 (190) cm	189 (295) cm	252 (370) cm	378 (545) cm	504 (725) cm	630 (920) cm	1,5 m <sup>2</sup>
RH Logic 4 Exclusive with neckrest	100 (120) cm	200 (230) cm	300 (350) cm	400 (470) cm	590 (690) cm	780 (930) cm	970 (1150) cm	1,7 m <sup>2</sup>
RH Logic 4 Exclusive without neckrest	100 (110) cm	180 (210) cm	270 (320) cm	360 (430) cm	530 (640) cm	700 (850) cm	890 (1040) cm	1,7 m <sup>2</sup>
Activ 200	60 (60) cm	90 (100) cm	130 (150) cm	170 (200) cm	250 (300) cm	340 (390) cm	420 (490) cm	
Activ 220	60 (60) cm	100 (120) cm	150 (170) cm	200 (230) cm	290 (330) cm	390 (450) cm	480 (550) cm	
Activ 202	60 (60) cm	100 (120) cm	140 (170) cm	190 (220) cm	270 (320) cm	360 (430) cm	460 (530) cm	
Activ 222	60 (80) cm	110 (130) cm	160 (180) cm	210 (240) cm	310 (360) cm	410 (480) cm	510 (600) cm	
Seat Saddle RH8 + Backrest RH17	62 (62) cm	85 (90) cm	115 (130) cm	150 (175) cm	220 (250) cm	285 (340) cm	370 (420) cm	
Seat Taburett RH9 + Backrest RH17	120 (120) cm	120 (120) cm	120 (120) cm	120 (170) cm	210 (240) cm	270 (300) cm	330 (390) cm	
Seat Limpan RH7 + Backrest RH17	60 (60) cm	60 (95) cm	110 (110) cm	110 (155) cm	110 (215) cm	220 (300) cm	220 (370) cm	
Seat Saddle RH8	62 (62) cm	62 (62) cm	85 (90) cm	100 (120) cm	145 (165) cm	190 (225) cm	230 (280) cm	
Seat Taburett RH9	120 (120) cm	120 (120) cm	120 (120) cm	120 (120) cm	120 (160) cm	170 (190) cm	200 (250) cm	
Seat Limpan RH7	60 (60) cm	60 (60) cm	60 (60) cm	120 (120) cm	120 (120) cm			
Seat Alternative RH11 + Backrest Alternative RH9	55 (55) cm	80 (90) cm	120 (130) cm	150 (170) cm	220 (250) cm	285 (340) cm	360 (410) cm	

\* For exact measurements in cm, contact your dealer or RH Chairs.

# Upholstery

## Extended

### RH Extended Fabric & Colour Programme

We also offer an expanded selection of textiles in different colors from different textile suppliers who we work with. Textile groups are tested and approved for our quality requirements. The delivery time is 25 working days.

### Price group 3

Uno - Svensson Markspelle 85% wool, 12% polyamide, 3% lycra	Flex - Gabriel 100% polyester	Valencia - Scan Aprima Pthalate-free PVC	Fame (non std) - Gabriel 95% wool, 5% polyamid
Antistatic synthetic leather - Nevotex 84,5% PVC, 15,5% polyester	Heidal - GU 80% wool, 10% polyamide, 10% viscose	24/7+ - Camira Fabrics 50 % polyamide, 33% wool, 10% visil, 7% viscose	Xtreme Plus (non std) - Camira Fabrics 100% recycled polyester
Sting Plus - Camira Fabrics 75% wool, 25% nettle fibre	Urban Plus - Camira Fabrics 100% recycled polyester	Oxygene - Camira Fabrics 90% wool, 10% nylon	Cordoba - Nevotex Pthalate-free PVC, cotton backing
Polo2 - Kvadrat 90% worsted new wool, 10% polyamide	Basic - Bogesund 100% wool	Adrenalin Plus - Camira Fabrics 95% wool, 5% polyamide	Advantage - Camira Fabrics 30% wool, 70% polypropylene
Marin Line Plus - Camira Fabrics 67% wool, 33% FR viscose blend	Blazer I & II - Camira Fabrics 100% wool	Nuna Plus- Camira Fabrics 95% wool, 5% polyamide	Globe - Gabriel 100% polyester
Interglobe Wool 2 - Gabriel 100% pure new wool	Novo2 - Gabriel 100% pure new wool	Pixel - Gabriel 100% worsted wool	Modal Point - GU 70% wool, 30% viscose
Nova - K&R 100% polyester	Clara - Kvadrat 92% worsted new wool, 8% polyamide		

### Price group 4

Gaja (non std) - Gabriel 100% worsted wool	Boss - Gabriel 90% wool, 10% polyamide	Tonus 3 - Kvadrat 90% new wool, 10% helanca	Pro2 - Kvadrat 100% polyester Trevira CS
Hallingdal - Kvadrat 70% new wool, 30% viscose	Steelcut Trio (non std) - Kvadrat 90% worsted new wool, 10% polyamide	Remix (non std) - Kvadrat 90% pure wool, 10% polyamide	Steelcut - Kvadrat 90% worsted new wool, 10% polyamide
Wafer - Kvadrat 100% polyurethane (surface) polyester (backing)	Morgedal - GU 70% wool, 30% viscose	Gandal - GU 96% wool, 4% polyamide	Arabesque - Väveriet 92% wool, 8% polyamide
Dotcom - Väveriet 100% polyester Trevira CS	Metroplis - Väveriet 85% wool, 15% polyamide	Soft - Väveriet 75% wool, 25% viscose	Nexus (non std) - Camira Fabrics 100% polyester
Global ESD - Bogesund 90% wool, 10% metal fibres	Mecano - Bogesund 100% wool	Snowball - Väveriet 80% wool, 13% viscose, 7% polyamide	Spray - Bogesund 85% wool, 15% polyamide
Monochrome - Bogesund 85% wool, 15% polyamide	Tweed - Bute 100% pure new wool	Luna - Gabriel 90% wool, 10% polyamide	Mira - Gabriel 65% wool, 31% hemp, 4% polyamide
Amdal - GU 70% wool, 30% viscose	Ambla (non std) - Jørgensen PVC based synthetic leather	Bonus - K&R 85% polyester, 15% polyamide	Dolce - Scan Aprima 100% polyurethane (surface), rayon (backing)
Bubbles - Väveriet 85% wool, 15% polyamide			

### Price group 5

Brink - Svensson Markspelle 85% wool, 15% polyamide	Comfort + (non std) - Gabriel 88% polyester, 12% polyurethane	Gaja Antistatic (non std) - Gabriel 94% wool, 4% polyamide, 2% stainless steel	Flora 2 - Kvadrat 90% new wool, 10% polyamide
Vadal - GU 87% wool, 5% viscose, 8% polyamide	Vadal Uni - GU 92% wool, 8% polyamide		

### COM (Customers Own Material)

Customers own supplied fabric require 25 working days from order confirmation date. Additional time for fabric testing may be required. Priced as Price Group 3 exclusive of fabric cost.

### Specials

Other demands on request.

### Textile Manufacturers

Camira Fabrics	<a href="http://www.camirafabrics.com">www.camirafabrics.com</a>
Gabriel	<a href="http://www.gabriel.dk">www.gabriel.dk</a>
Kvadrat	<a href="http://www.kvadrat.dk">www.kvadrat.dk</a>
Elmo Leather	<a href="http://www.elmoleather.com">www.elmoleather.com</a>
Svensson Markspelle	<a href="http://www.ludvigsvensson.com">www.ludvigsvensson.com</a>
GU	<a href="http://www.gu.no">www.gu.no</a>
Nevotex	<a href="http://www.nevotex.se">www.nevotex.se</a>
Bogesund	<a href="http://www.bogesunds.se">www.bogesunds.se</a>
Väveriet	<a href="http://www.vaveri1.se">www.vaveri1.se</a>
Jørgensen	<a href="http://www.brodernejorgensen.se">www.brodernejorgensen.se</a>
Bute	<a href="http://www.butefabrics.com">www.butefabrics.com</a>
K&R	<a href="http://www.kr-textil.de">www.kr-textil.de</a>
Scan Aprima	<a href="http://www.scanaprima.no">www.scanaprima.no</a>

# Upholstery

## RH Standard Fabric & Colour Programme

This is RH's standard selection of textiles and colors for our chairs from renowned suppliers who we work with. Normal delivery from RH's standard selection is 20 working days.

### Price group 1

Xtreme + – CAMIRA  
100% polyester

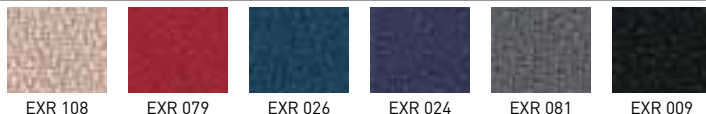

EXR 108 EXR 079 EXR 026 EXR 024 EXR 081 EXR 009

### Price group 2

Fame – GABRIEL  
95% wool, 5% polyamide



FM 64089 FM 64058 FM 66002 FM 66075 FM 66071 FM 66061 FM 60019 FM 60051 FM 60999

### Price group 3

Remix – KVADRAT  
90% wool,  
10% polyamide

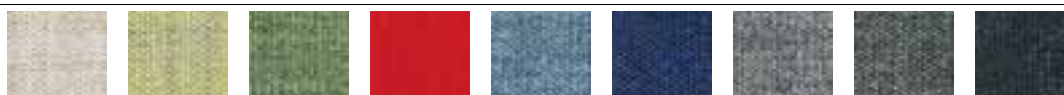

RMX 223 RMX 923 RMX 933 RMX 1662 RMX 733 RMX 773 RMX 133 RMX 163 RMX 183

Steelcut Trio – KVADRAT  
90% wool, 10% polyamide

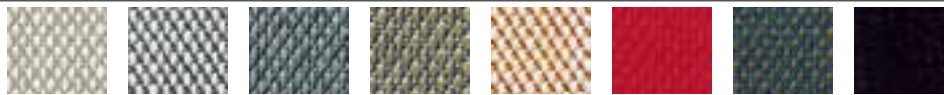

STT 213 STT 133 STT 153 STT 253 STT 413 STT 1652 STT 883 STT 1192

Nexus – CAMIRA  
100% polyester



NEX 02 NEX 14 NEX 05 NEX 16 NEX 08 NEX 15 NEX 07 NEX 11 NEX 13

Gaja – GABRIEL  
100% wool



GAJA 60003 GAJA 60999 GAJA 66004 GAJA 66005

### Price group 4

Move – GABRIEL  
95% wool, 5% polyamide

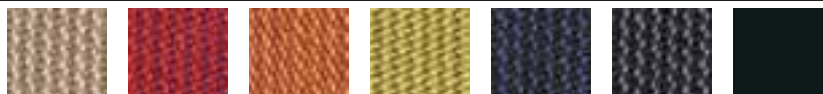

MOVE 2101 MOVE 4101 MOVE 4103 MOVE 5101 MOVE 9101 MOVE 9102 MOVE 9105

Comfort – GABRIEL  
88% polyester,  
12% polyurethane



CMF 0004 CMF 1414 CMF 0040 CMF 0049 CMF 0050

### Price group 6

Elmosoft – ELMO LEATHER



EL 99999

Elmosoft Piqué – ELMO LEATHER



EL 99999L



The human body is an anatomical miracle. And the better we take care of our bodies, the better we perform. That is as true when it comes to sporting activities as it is for when we are carrying out what we might assume are the most routine of tasks, such as sitting. When we sit in a chair that takes into account our body's natural ease of movement, we breathe better. When we breathe better, it's easier for us to concentrate and we perform better. These are the factors we take into account when designing our chairs. For our customers, that can make the difference between good business and great business.

### **RH Chairs. Designed for human performance**



**RH Chairs**  
Upper Tulse Hill Trading Estate  
5 Somers Place, London, SW2 2AL  
Tel: 020-8683 9930, Fax: 020-8683 9940  
info@rhform.co.uk, www.rhchairs.co.uk

**Head office:**  
RH Chairs  
Vallgatan 1, P.O. Box 294  
SE-571 23 Nässjö, Sweden



The Back Centre Ltd  
Erme Court  
Leonards Road  
Ivybridge  
Devon, PL21 0-SZ  
T: 01752 893414  
E: sales@backcentre.co.uk  
W: www.backcentre.co.uk

